



GAM
GONZAGARREDI
MONTESSORI





GAM BIBLIOTECHE

GAM LIBRARIES



006 ACCOGLIENZA RECEPTION

008 **banco accoglienza**
reception desk

016 **lockers**
lockers

020 **comunicazione**
communication



026 EMEROTECA, AMBIENTI INFORMALI NEWSPAPER LIBRARY, INFORMAL ENVIRONMENTS

028 **espositori per riviste**
magazine displays

034 **sedute e tavoli informali**
informal seats and tables



044 AMBIENTI PER CONSULTAZIONE, LETTURA, STUDIO CONSULTATION, READING, STUDY AREAS

046 **sistema MODULAR**
MODULAR shelving system

060 **sistema EPIFANO**
EPIFANO shelving system

064 **espositori per libri e supporti digitali**
book and multimedia display units

068 **tavoli per consultazione e lettura**
consultation and reading tables

074 **sedute lettura e multiuso**
multipurpose and reading chairs

078 **arredi fonoassorbenti**
sound-absorbing furnishings





082 SPAZI PER RAGAZZI E BAMBINI CHILDREN AND TEENS ENVIRONMENTS

- 084** scaffali, espositori, contenitori
shelves, displays, cabinets
- 092** tavoli e sedute
tables and chairs
- 098** pezzi speciali
special items
- 102** pedane, pouf, morbidi
stages, poufs, soft furnishings
- 110** sistema parete
wall system



114 ABACHI SCAFFALI, CARTELLE COLORI SHELVES CODIFICATION, COLOR CHARTS

- 116** abaco SISTEMA MODULAR
MODULAR SHELVING SYSTEM – item codes
- 124** abaco SISTEMA EPIFANO
EPIFANO SHELVING SYSTEM – item codes
- 128** cartelle colori
color charts



GAM GAM

- 138** GAM biblioteche
GAM libraries
- 172** altri progetti GAM
other GAM projects
- 180** design GAM
GAM design
- 182** certificazioni
certifications







ACCOGLIENZA

RECEPTION

La biblioteca si presenta. Invita a entrare, informa e guida. Lo spazio d'ingresso è significativo, attraente, amichevole. Non trasmette timore, dà il benvenuto. L'allestimento comunica a prima vista il carattere e le offerte della biblioteca. Il banco non è una barriera, suggerisce di avvicinarsi. Le pareti espongono novità e programmi, accolgono piccole mostre temporanee. Gli utenti capiscono come orientarsi e trovano contenitori dove riporre i loro oggetti, per muoversi liberamente tra gli ambienti della biblioteca.

The library introduces itself. It invites the community to enter, it informs and guides.
The entrance space is not a barrier, it's attractive and welcoming.
At first glance, the layout communicates the library character and offerings. The reception encourages the approach.
The walls display news and programs, welcoming small temporary exhibitions.
Users understand how to orient themselves and find lockers to store their belongings to move freely among the library environments.

ACCOGLIENZA

RECEPTION

BANCO ACCOGLIENZA RECEPTION DESK





Gli elementi modulari che compongono il sistema consentono di realizzare banchi diversi per forma, dimensione e dotazioni. Gli elementi principali compongono volume ad altezza tavolo: monolitico, minimale, monocromo. Al volume si aggiungono accessori: schermi, portaborse, espositori, contenitori, tavoli per consultazioni. Le composizioni giocano sul rapporto volume-accessori e sulla combinazione di due materiali o colori.

The modular elements that make up the reception system make it possible to create counters that differ in shape, size and equipment. The focus is on volume at table height: monolithic, minimalist, monochrome. The system comes with a wide range of accessories: grids, display stands, cabinets, consultation desks. The compositions balance volume, accessories, materials and colors combinations.



PERSONALIZZAZIONE CUSTOMIZATION

Una serigrafia permette di creare banchi di forte impatto estetico: la planarità delle superfici agevola l'applicazione di immagini o fotografie anche di grandi dimensioni.

A screen printing allows to create unique reception desks: the flat surfaces facilitate the application of images or pictures, even in large format.

ACCOGLIENZA

RECEPTION

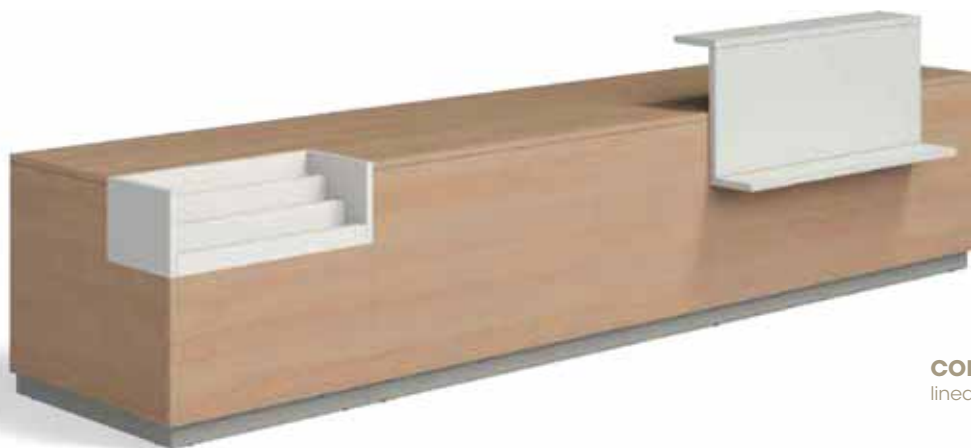

COMPOSIZIONE LINEARE
linear configuration



**COMPOSIZIONE AD ANGOLO
CON TAVOLO DI CONSULTAZIONE ALTO**
corner configuration with high desk

COMPOSIZIONI LINEARI

LINEAR CONFIGURATIONS

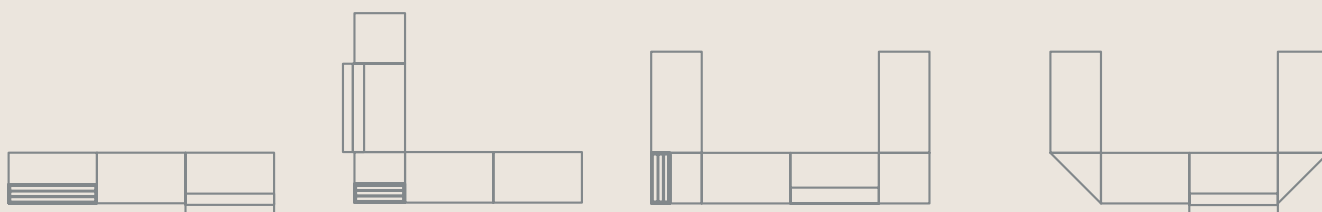



COMPOSIZIONE CURVILINEA
curvilinear configuration



**COMPOSIZIONE A TRE LATI
CON ANGOLI STONDATI**
three-sided configuration
with rounded corners

COMPOSIZIONI CURVILINEE
CURVILINEAR CONFIGURATIONS

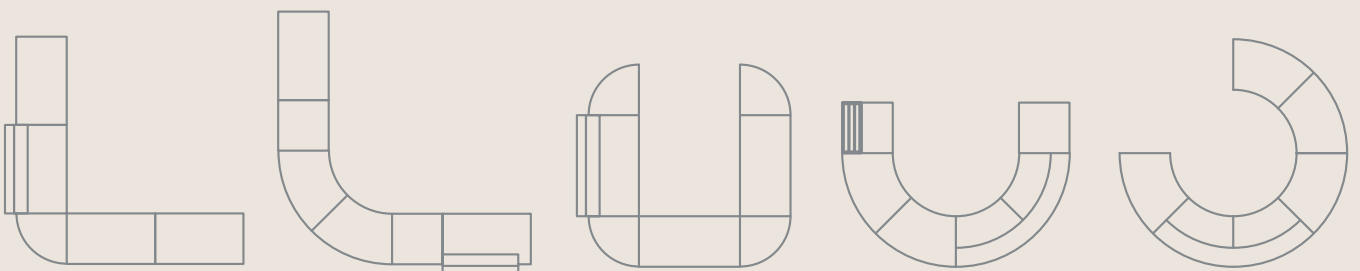



ACCESSORI
accessories

Contenitori chiusi ad ante e cassettiere completano le composizioni dei banchi per l'accoglienza.

Storage units and pedestals complete the reception desk configurations.



KUBIX
KUBIX

Poltroncina operativa con braccioli fissi, sedile e schienale imbottito.

Regolazione manuale della seduta in altezza e in profondità. Base in nylon.

Task chair with fixed armrests, upholstered seat and back.
Manual adjustment of the seat in height and depth. Nylon base.

61x55xh42/54 - 88/100 cm

GU0001179



KARMA
KARMA

Poltroncina operativa con braccioli regolabili, sedile imbottito e schienale in rete.

Regolazione manuale della seduta in altezza e in profondità. Base in alluminio.

Task chair with adjustable armrests, upholstered seat and mesh backrest.

Adjustable seat in height and depth. Aluminum base.

68x54xh42/54 - 100/113 cm

GC0003869



KORIAM MESH
KORIAM MESH

Poltroncina semidirezionale con braccioli, sedile imbottito e schienale alto in rete. Braccioli fissi in alluminio, imbottiti.

Regolazione manuale della seduta in altezza e in profondità. Base in alluminio lucido.

Semi-executive armchair with armrests, upholstered seat and high mesh backrest. Fixed upholstered armrests in aluminum. Adjustable seat in height and depth. Polished aluminum base.

60x60xh42/54 - 110/122 cm

GC0005637

ACCOGLIENZA

RECEPTION



MODULO AUTONOMO
basic reception desk

80x120xh75 cm **GB0000050**
80x140xh75 cm **GB0000049**
80x160xh75 cm **GB0000045**

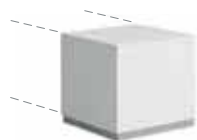

TERMINALE DESTRO
right end

80x40xh75 cm **GB0000001**
80x60xh75 cm **GB0000002**
80x80xh75 cm **GB0000003**
80x120xh75 cm **GB0000004**
80x140xh75 cm **GB0000005**
80x160xh75 cm **GB0000006**

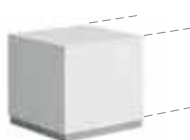

TERMINALE SINISTRO
left end

80x40xh75 cm **GB0000011**
80x60xh75 cm **GB0000012**
80x80xh75 cm **GB0000013**
80x120xh75 cm **GB0000014**
80x140xh75 cm **GB0000015**
80x160xh75 cm **GB0000016**

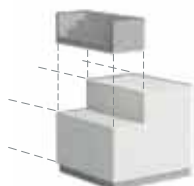

TERMINALE CON INCASSO DESTRO
right recessed end

80x80xh75 cm **GB0000063**

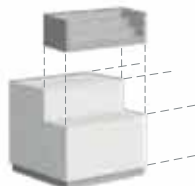

TERMINALE CON INCASSO SINISTRO
left recessed end

80x80xh75 cm **GB0000062**



TERMINALE CURVO DESTRO
right curved end

R100x80xh75 cm **GB0000031**
R100ex80xh75 cm **GB0000032**



TERMINALE CURVO SINISTRO
left curved end

R100x80xh75 cm **GB0000021**
R100ex80xh75 cm **GB0000022**



INTERMEDIO
intermediate

80x80xh75 cm **GB0000041**
80x120xh75 cm **GB0000042**
80x140xh75 cm **GB0000043**
80x160xh75 cm **GB0000044**



INTERMEDIO CON INCASSO
recessed intermediate

80x80xh75 cm **GB0000082**

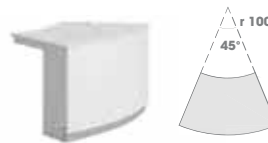

INTERMEDIO CURVO
curved intermediate

R100x80xh75 cm **GB0000051**
R100ex80xh75 cm **GB0000033**

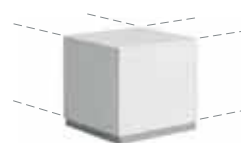

ANGOLO
corner

80x80xh75 cm **GB0000061**

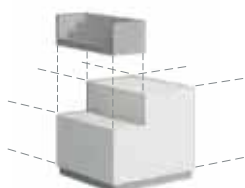

ANGOLO CON INCASSO DESTRO
right recessed corner

80x80xh75 cm **GB0000071**

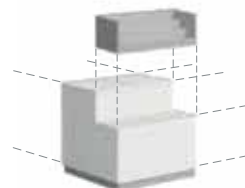

ANGOLO CON INCASSO SINISTRO
left recessed corner

80x80xh75 cm **GB0000081**



ANGOLO TRIANGOLO
triangle-shaped corner

80xh75 cm **GB0000091**



ANGOLO CURVO
curved corner

80xh75 cm **GB0000101**



PIANO CONSULTAZIONE BASSO
low desk

60x80xh75 cm
60x120xh75 cm
60x140xh75 cm
60x160xh75 cm

GB0000141
GB0000142
GB0000143
GB0000144

80x80xh75 cm
80x120xh75 cm
80x140xh75 cm
80x160xh75 cm

GB0000145
GB0000146
GB0000147
GB0000148



PIANO CONSULTAZIONE ALTO
high desk

60x80xh100 cm
60x120xh100 cm
60x140xh100 cm
60x160xh100 cm

GB0000151
GB0000152
GB0000153
GB0000154

80x80xh100 cm
80x120xh100 cm
80x140xh100 cm
80x160xh100 cm

GB0000155
GB0000156
GB0000157
GB0000158



ESPOSITORE
display stand

60 cm **GB0000161**
80 cm **GB0000162**
120 cm **GB0000163**
140 cm **GB0000164**
160 cm **GB0000165**



RIALZO PORTABORSE
high bag-rack

80 cm **GB0000171**
120 cm **GB0000172**
140 cm **GB0000173**
160 cm **GB0000174**



VANO SCHERMO
straight top compartment

80 cm **GB0000181**
120 cm **GB0000182**
140 cm **GB0000183**
160 cm **GB0000184**



VANO SCHERMO ANGOLARE
corner top compartment

80x80 cm **GB0000185**



VANO SCHERMO CURVO
curved top compartment

R55x25 cm **GB0000195**
R155x25 cm **GB0000191**



CONTENITORE RETROBANCO
back desk cabinet

40x86,5xh75 cm **GB0000201**
40x96,5xh75 cm **GB0000202**
60x86,5xh75 cm **GB0000203**
60x96,5xh75 cm **GB0000204**
serratura/lock **GB0000216**



CONTENITORE RETROBANCO ANTE IN VETRO E SERRATURA
back desk cabinet with glass doors and lock

40x86,5xh75 cm **GB0000286**
40x96,5xh75 cm **GB0000287**
60x86,5xh75 cm **GB0000288**
60x96,5xh75 cm **GB0000289**



CASSETTIERA SU RUOTE
mobile pedestal

42x56xh58 cm **GB0000211**



PANNELLO SOSPESO
hanging panel

ml/m **GB0000231**

info

SCRITTA ADESIVA
adhesive writing

mq **GC0001520**



BRACCIO PORTA MONITOR
monitor arm

GB0000253



PASSACAVI
cable port

Ø6 cm

GU0000098



TOP ACCESS
top access

2 prese UNEL
e 2 prese rete RJ45 **GB0000260**
4 prese UNEL
e 2 prese rete RJ45 **GB0000267**



CANALINA CAVI
cable tray

80 cm **GC0005936**
120 cm **GC0001786**
140 cm **GC0001787**
160 cm **GC0001788**

ACCOGLIENZA

RECEPTION

LOCKERS LOCKERS





**Sistema di contenitori guardaroba con vani chiusi ad anta.
Moduli di varie dimensioni sono aggregabili in linee
da accostare a parete o in nuclei self standing.
Ante di varie finiture consentono infinite composizioni.**

Lockers with doors.
Modules of different sizes can be placed in row against the wall
or in self-standing groups.
Various door finishes offer countless compositions.

DIMENSIONI

SIZES

**Il sistema comprende moduli di due larghezze e tre altezze,
composti da vani di tre differenti dimensioni.**

Modules in two widths and three heights, made up of compartments in three different sizes.

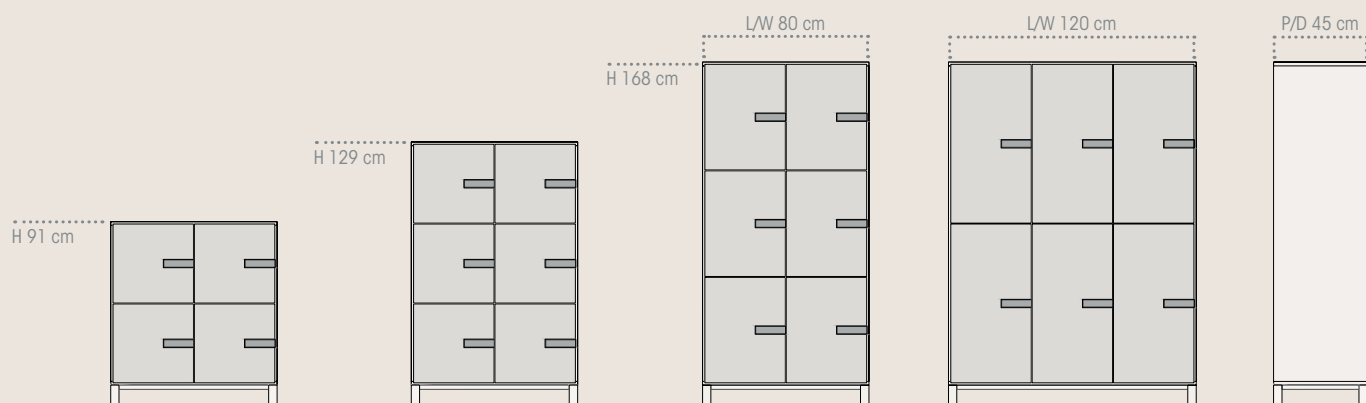

ACCOGLIENZA

RECEPTION



Le ante sono caratterizzate dal disegno essenziale delle maniglie lineari a incasso. Tutte le ante hanno serrature a chiave. Sono disponibili serrature a combinazione e lucchettiabili.

The doors have ergonomic recessed handles and key locks. Padlockable and combination locks are also available.



SERRATURA A CHIAVE
key lock

GPN617000



PASSPARTOUT
master key

GPN617001



SERRATURA A COMBINAZIONE
combination lock

GPN617002



SERRATURA LUCCHETTABILE
padlockable lock

GPN617003

***lucchetto a parte**
padlock not included



TELAIO SU PIEDI
base on feet

45x45xh12 cm

GPN615000



TELAIO SU RUOTE
base on castors

GPN615010



ZOCCOLO
plinth

GPN615020

80x45xh12 cm

GPN615001

GPN615011

GPN615021

120x45xh12 cm

GPN615002

GPN615012

GPN615022

La base dei contenitori è un telaio metallico su piedi o su ruote. Su richiesta può essere uno zoccolo in tinta.

The base of the cabinets is a metal frame on feet or castors. On request, the base can be a matching plinth.

CONTENITORI – VANO UTILE INTERNO | CABINETS – INTERNAL USABLE SPACE **H 36 37x42 cm**

L/W 80 cm

L/W 120 cm

CONTENITORE AD ANTE SINGOLE

single-door cabinet

H 91 cm

H 79 cm senza piedi | without feet



su piedi
on feet **GPN600600**

senza piedi
without feet **GPN600601**

su ruote
on castors **GPN600602**



su piedi
on feet **GPN610600**

senza piedi
without feet **GPN610601**

su ruote
on castors **GPN610602**

CONTENITORE AD ANTE SINGOLE

single-door cabinet

H 129 cm

H 117 cm senza piedi | without feet



su piedi
on feet **GPN601600**

senza piedi
without feet **GPN601601**

su ruote
on castors **GPN601602**



su piedi
on feet **GPN611600**

senza piedi
without feet **GPN611601**

su ruote
on castors **GPN611602**

CONTENITORE AD ANTE SINGOLE

single-door cabinet

H 168 cm



su piedi
on feet **GPN602600**



su piedi
on feet **GPN612600**

CONTENITORI – VANO UTILE INTERNO | CABINETS – INTERNAL USABLE SPACE **H 49 37x42 cm**

L/W 80 cm

L/W 120 cm

CONTENITORE SPOGLIATOIO

AD ANTE SINGOLE

single-door closet

H 168 cm



su piedi
on feet **GPN612604**



su piedi
on feet **GPN612603**

CONTENITORI – VANO UTILE INTERNO | CABINETS – INTERNAL USABLE SPACE **H 74 37x42 cm**

L/W 80 cm

L/W 120 cm

CONTENITORE SPOGLIATOIO

AD ANTE SINGOLE

single-door closet

H 168 cm



su piedi
on feet **GPN603000**



su piedi
on feet **GPN613000**

ACCOGLIENZA

RECEPTION

COMUNICAZIONE COMMUNICATION





PANNELLI AUTOPORTANTI BIFACCIALI

Free-standing two-sided noticeboards

Sistema di pannelli autoportanti in vari materiali e finiture, con struttura in acciaio su piedi o su ruote.

Freestanding panels in various materials and finishes, with steel structure on feet or wheels.



PANNELLI PER PARETI COMUNICATIVE

Panels for communication walls

Sistema di pannelli in vari materiali e finiture, da appendere a parete.

Disponibili in più misure, coordinate per composizioni.

Panels in various materials and finishes, to hang on the wall. Available in several sizes.

MATERIALI E COLORI

MATERIALS AND COLOURS

Pannelli lisci, con fori o fresature, in sughero, scrivibili neri o bianchi, magnetici, fonoassorbenti in molti colori.

Plain panels, with holes or slots, in cork, in black or white writeable HPL, magnetic, sound-absorbing in many different colors.



ACCOGLIENZA

RECEPTION



PANNELLO AUTOPORTANTE BIFACCIALE IN LEGNO FORATO
free-standing wooden noticeboard with holes

su piedi
on feet **GP0909252**

60x60xh168 cm

su ruote
on castors **GP0909253**



PANNELLO AUTOPORTANTE BIFACCIALE IN SUGHERO
free-standing cork noticeboard

su piedi
on feet **GP0909254**

60x60xh168 cm

su ruote
on castors **GP0909255**



PANNELLO AUTOPORTANTE BIFACCIALE IN LAMINATO BIANCO
free-standing white HPL writing board

su piedi
on feet **GP0909256**

60x60xh168 cm

su ruote
on castors **GP0909257**



PANNELLO AUTOPORTANTE BIFACCIALE IN LAMINATO LAVAGNA
free-standing black HPL writing board

su piedi
on feet **GP0909258**

60x60xh168 cm

su ruote
on castors **GP0909259**



PANNELLO AUTOPORTANTE BIFACCIALE FONOASSORBENTE
free-standing sound-absorbing noticeboard

su piedi
on feet **GP0909260**

60x60xh168 cm

su ruote
on castors **GP0909261**



PANNELLO AUTOPORTANTE BIFACCIALE IN LEGNO CON GUIDE PER TASCHE*
free-standing wooden noticeboard with slots*

su piedi
on feet **GP0909262**

60x60xh168 cm

su ruote
on castors **GP0909263**



PANNELLO AUTOPORTANTE BIFACCIALE IN LEGNO CON GUIDE PER TASCHE E IN LAMINATO BIANCO*
free-standing white HPL and wooden noticeboard with slots*

su ruote
on castors **GP0909269**

60x60xh168 cm



PANNELLO AUTOPORTANTE BIFACCIALE IN LEGNO CON GUIDE PER TASCHE E IN SUGHERO*
free-standing cork and wooden noticeboard with slots*

su ruote
on castors **GP0909270**

60x60xh168 cm

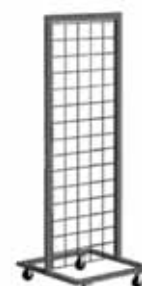

PANNELLO-GRIGLIA AUTOPORTANTE IN METALLO
free-standing metal grid

su piedi
on feet **GP0909266**

60x60xh168 cm

su ruote
on castors **GP0909267**



PANNELLO IN LEGNO FORATO
wooden wall panel with holes

80xh77 cm
120xh77 cm

GP0945011
GP0945012



**SCATOLA PER PANNELLO
IN LEGNO FORATO**
box for wooden noticeboard with holes

39x25xh26 cm

GP0944023



PANNELLO IN SUGHERO
cork wall panel

80xh77 cm
120xh77 cm

GP0945031
GP0945032



PANNELLO IN LAMINATO BIANCO
white HPL wall panel

80xh77 cm
120xh77 cm
120xh100 cm

GP0945041
GP0945042
GP0945054



PANNELLO IN LAMINATO LAVAGNA
black HPL writing board wall panel

80xh77 cm
120xh77 cm
120xh100 cm

GP0945051
GP0945052
GP0945053



PANNELLO FONOASSORBENTE
sound-absorbing wall panel

80xh77 cm
120xh77 cm

GP0945061
GP0945062



**PANNELLO IN LEGNO
CON GUIDE PER TASCHE***
wooden wall panel with slots*

80xh77 cm
120xh77 cm

GP0945021
GP0945022

***TASCA non inclusa**
pocket not included

GC0001426



PANNELLO LIBRERIA A MURO
wall-mounted bookcase panel

100xh100 cm

GA0256909



**PANNELLO-GRIGLIA CON TELAIO
IN LEGNO**
free-standing grid with wooden frame

60xh160 cm

GP0909268



**ESPOSITORE TOTEM
SU RUOTE A 5 RIPIANI**
5-shelf totem display on castors

75x75xh180 cm

GV000553



**ESPOSITORE TOTEM
SU RUOTE A 6 RIPIANI**
6-shelf totem display on castors

75x75xh210 cm

GV000554



**ESPOSITORE A PARETE PORTARIVISTE
A 4 RIPIANI**
4-shelf wall-mounted magazine display

45x15xh128 cm
60x15xh128 cm
90x15xh128 cm

GV000557
GV000558
GV000549



**ESPOSITORE A PARETE PORTARIVISTE
A 5 RIPIANI**
5-shelf wall-mounted magazine display

45x15xh160 cm
60x15xh160 cm
90x15xh160 cm

GV000550
GV000551
GV000552



**ESPOSITORE BIFACCIALE
SU RUOTE A 3/4 RIPIANI**

3/4-shelf double-sided display on castors

53x53xh150 cm
53x53xh175 cm

GB2E00B23
GB2E00C23



**CARRELLO PORTALIBRI A 4 RIPIANI
IN LEGNO CON STRUTTURA METALLICA**

book trolley with 4 inclined shelves

61x54xh141 cm

GB0Y00107



**CARRELLO PORTALIBRI A 3 RIPIANI
IN LEGNO E METALLO**

book trolley with 3 inclined metal shelves

74/94x42xh95 cm

GU0000133



**BOX RESTITUZIONE LIBRI
DA INTERNO**

indoor book return box

75x75xh95 cm

GV0001728



**BOX RESTITUZIONE LIBRI
DA ESTERNO 24H**

24h outdoor book return box

70x70xh118 cm
grafica | graphic design

GC0003530
GC0003675



**BOX DOPPIO RESTITUZIONE LIBRI
E MATERIALE MULTIMEDIALE
DA ESTERNO 24H**

24h outdoor book & multimedia return box

105x70xh118 cm
grafica | graphic design

GC0005656
GC0003675





EMEROTECA, AMBIENTI INFORMALI

NEWSPAPER LIBRARY, INFORMAL ENVIRONMENTS

La biblioteca è una piazza, aperta e vivace, dove corrono le informazioni. Un luogo che invoglia a trattenerci, liberamente, senza impegno.

L'emeroteca è lo spazio dell'attualità. Offre a tutti giornali e riviste del momento e conserva intere collezioni. Espone locandine di mostre e spettacoli e ogni informazione di comunità.

Contenitori per quotidiani e rotocalchi, espositori, tavoli e sedute informali allestiscono spazi amichevoli. Arredi flessibili supportano tecnologie per i nuovi modi di consultazione e lettura.

The library is a like lively square, a place that invites you to spend time freely.

The newspaper library is the space of current events. It offers newspapers and magazines of the day and holds entire collections. It displays posters of exhibitions and shows and all community information.

Display, tables and informal seats set up welcoming environments and hold multimedia for new ways of consulting and reading.

EMEROTECA, AMBIENTI INFORMALI

NEWSPAPER LIBRARY,
INFORMAL ENVIRONMENTS

ESPOSITORI PER RIVISTE MAGAZINE DISPLAYS





GAM BOX
GAM BOX

Sistema modulare di espositori-contenitori per riviste e libri.
L'elemento base è un cubo in metallo, contenitore da un lato,
espositore dall'altro.
**Il sistema consente di comporre totem di varie altezze, pareti
di forma libera, sedute.**

Modular system of display units/boxes for magazines and books.
The basic element is a metal cube which works as a box on one side
and display on the other.
The system allows to build totems, display walls, seats.



GAM BOX A PORTELLO FISSO
GAM BOX with door

32x32x32 cm

GB5000207



GAM BOX PASSANTE
open GAM BOX

32x32x16 cm

GB5000107



CARRELLO GAM BOX
GAM BOX trolley

64x64x7 cm

GB0E00128



CUSCINO PER TORRE ESPOSITIVA
cushion for GAM BOX tower

64x64x8 cm

GAI000166



CUSCINO
cushion for GAM BOX row

32x96x5 cm

GAI201006

EMEROTECA, AMBIENTI INFORMALI

NEWSPAPER LIBRARY,
INFORMAL ENVIRONMENTS



GRIGLIE E PANNELLI ESPOSITORI

display grids and panels

**Espositori a parete e self standing.
Pannelli forati e griglie supportano accessori in metallo
e in plexiglas per mostrare libri e riviste.**

Wall and freestanding displays.
Perforated panels and grids with metal and plexiglas accessories
for displaying books and magazines.



**ESPOSITORE IN METALLO FORATO
SU PANNELLO IN LEGNO**
metal perforated display on wooden panel

110x110 cm

GB0E00127



**GRIGLIA SELF STANDING
SU UN PIEDE E 2 RUOTE**
display grid on castors

95x53xh175 cm

GB0E00225



GRIGLIA A PARETE
display grid

95xh175 cm
kit di fissaggio a parete
wall fastening kit for display grid

GB0E00125

GB0E00725

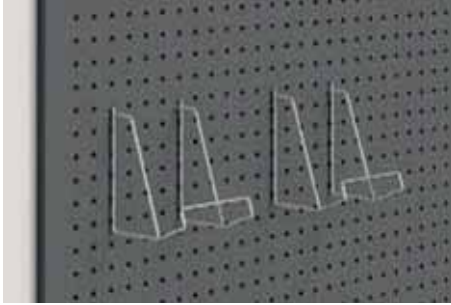

ESPOSITORE PLURIUSO – GAM 5
multipurpose display stand – GAM 5

Elemento in tondino metallico cromato, per esporre pubblicazioni di piccole dimensioni.

Display stand in chromed metal rod.

GB0E00010



ESPOSITORE UNIVERSALE PER LIBRI, GIORNALI, RIVISTE – GAM 6
book, newspapers and magazine display stand – GAM 6

Supporto multifunzione in tondino metallico cromato, utilizzabile in tre diverse posizioni: inclinata, orizzontale e a cestello.

Multipurpose display stand in chromed metal rod. It can be used in three different positions: inclined, horizontal and basket.

GB0E00011



ESPOSITORE IN PLEXIGLAS – GAM 7
plexiglas display stand – GAM 7

Tasca per l'esposizione temporanea di quotidiani e volumi di piccole dimensioni.

Display pocket for newspapers and small books.

GB0E00004



PIANO INCLINATO – GAM 8
inclined shelf – GAM 8

Espositore in metallo inclinato, per esporre frontalmente riviste, volumi chiusi o aperti e ogni pubblicazione che necessita di una superficie di supporto di grandi dimensioni.

Inclined metal display to show magazines frontally, closed or open volumes and any publication that requires a large support surface.

GB0E00001



PIANO ORIZZONTALE – GAM 9
horizontal display stand – GAM 9

Espositore orizzontale per volumi e supporti digitali.

Horizontal display stand for volumes and multimedia.

GB0E00002

EMEROTECA, AMBIENTI INFORMALI

NEWSPAPER LIBRARY,
INFORMAL ENVIRONMENTS

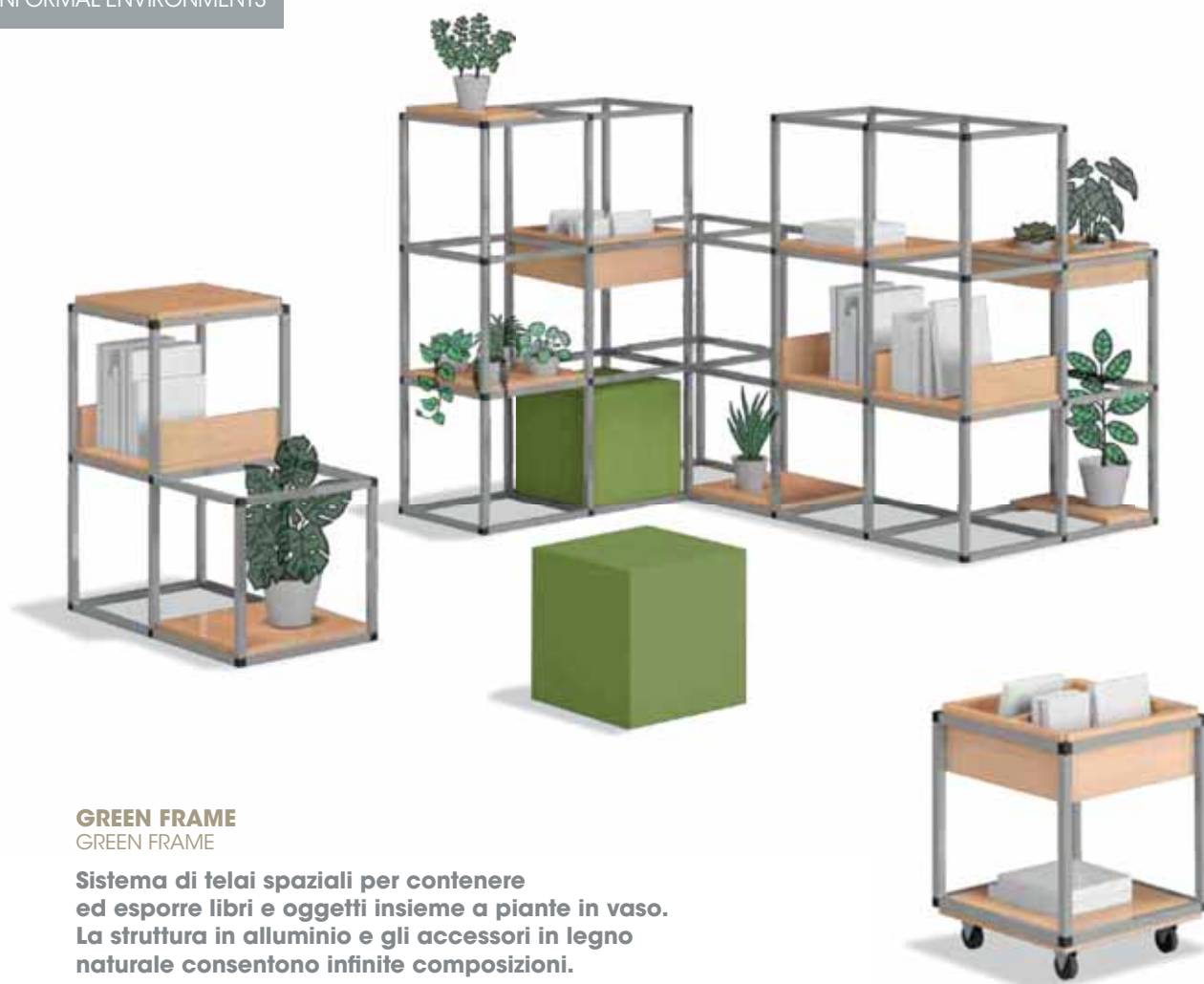

GREEN FRAME GREEN FRAME

Sistema di telai spaziali per contenere ed esporre libri e oggetti insieme a piante in vaso. La struttura in alluminio e gli accessori in legno naturale consentono infinite composizioni.

Frame system for holding and displaying books and objects together with potted plants. The aluminum structure and natural wood accessories allow to build countless compositions.

COMPONENTI COMPONENTS

GREEN FRAME è composto da pochi semplici elementi: barre di tubolare quadro in alluminio di un'unica lunghezza e nodi in plastica di quattro tipi.

GREEN FRAME is made of a few, simple elements: square tubular aluminum bars of a single length and plastic nodes of four types.

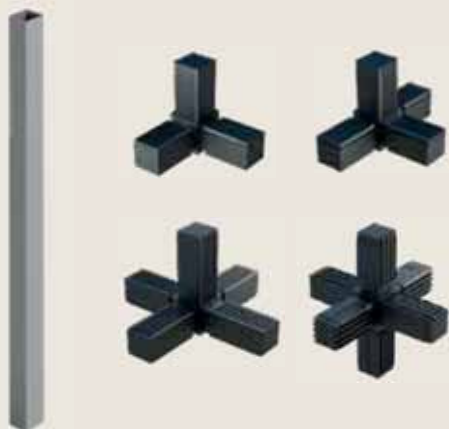



COMPOSIZIONE CUBO
cube configuration

40x40x40 cm

GPN800014



COMPOSIZIONE 3 CUBI
3-cube configuration

78x40x40/78 cm

GPN800015

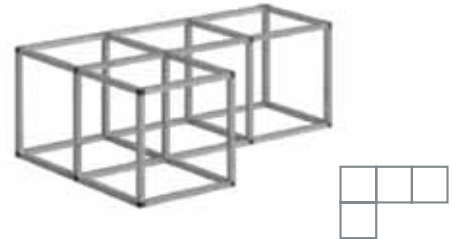

COMPOSIZIONE 4 CUBI
4-cube configuration

116x78x40 cm

GPN800016

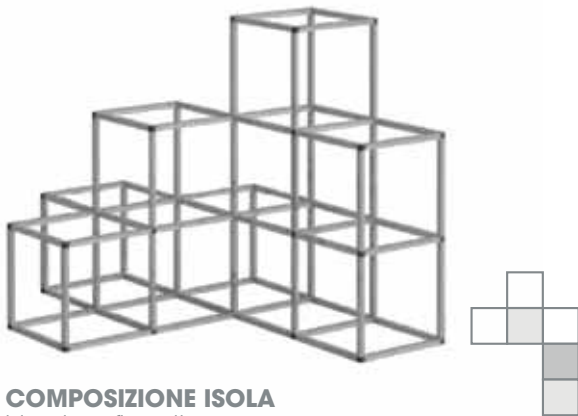

COMPOSIZIONE ISOLA
island configuration

116x154x40/78/116 cm

GPN800010



COMPOSIZIONE ESSE
S configuration

154x154x40/78/116 cm

GPN800033



PIANO PORTALIBRI
bookshelf

38x38x13 cm

GPN800035



MEZZO PIANO
shelf

38x19 cm

GPN800000



PIANO FORATO PORTAVASI
perforated pot holder

38x38 cm

GPN800001



CONTENITORE
tray

38x38x10 cm

GPN800002



CONTENITORE PORTALIBRI
bookcase

38x38x13 cm

GPN800036



BASE SU RUOTE
castor base

38x38x10,5 cm
76x38x10,5 cm

GPN800005
GPN800007



CUBO MORBIDO
soft cube

35x35x35 cm

GAI208004

EMEROTECA, AMBIENTI INFORMALI

NEWSPAPER LIBRARY,
INFORMAL ENVIRONMENTS

SEDUTE E TAVOLI INFORMALI INFORMAL SEATS AND TABLES



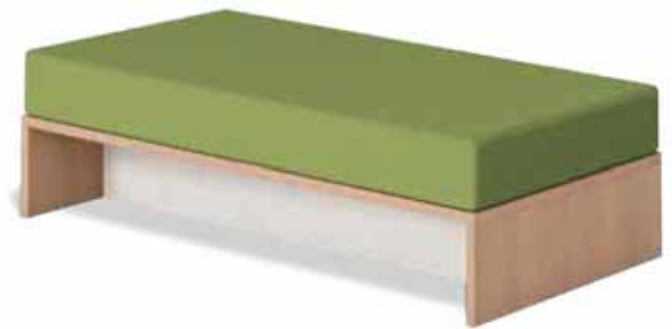

SISTEMA PANCHE ELLE

ELLE benches

Sistema composto da panche in legno dal design essenziale, che possono essere completate da cuscini e affiancate da contenitori a caselle per libri. Componibile, aggregabile, modulare, per formare isole o ampie zone di lettura.

System of wooden benches with an essential design, which can be completed with cushions and placed next to bookcases. Modular items to create islands or large reading areas.



PANCA ELLE
ELLE bench

160x80xh44 cm

GC0001061



PANCA ELLE CON CONTENITORE A 6 CASELLE

ELLE bench with 6-compartment book browser

160x80xh44 cm

GC0001062



PANCA ELLE CON CUSCINO
ELLE bench with upholstered cushion

160x80xh44 cm

GC0001064



PANCA ELLE CON MEZZO CUSCINO
ELLE bench with half upholstered cushion

160x80xh44 cm

GC0001065



PANCA ELLE CON CUSCINO E CONTENITORE A 6 CASELLE
ELLE bench with upholstered cushion and 6-compartment book browser

160x80xh44 cm

GC0001066

EMEROTECA, AMBIENTI INFORMALI

NEWSPAPER LIBRARY,
INFORMAL ENVIRONMENTS



BUKSOFA BUKSOFA

**Sistema di elementi in legno e imbottiti, per comporre pouf, poltrone, divani.
Pochi elementi consentono di realizzare infinite composizioni: lineari mono e bifronte, ad angolo, a isola.
Le basi con vani aperti contengono libri.**

System of wooden and upholstered items to compose poufs, armchairs, sofas.
Few elements allow you to create linear, single-sided, double-sided, corner, island compositions.
The open bases hold books.



BASE
base

60x60xh29 cm
60x75xh29 cm
75x75xh29 cm

GP0909290
GP0909291
GP0909292



BASE PORTALIBRI
bookcase base

60x60xh29 cm **GP0909293**



SCHIENALE
backrest

60x15xh66 cm **GP0909294**



SCHIENALE PORTALIBRI
bookcase backrest

60x15xh66 cm **GP0909295**



CONTENITORE
bookcase

60x60xh29 cm
60x75xh29 cm

GP0909296
GP0909297



CUSCINO SEDUTA
seat cushion

60x60xh9 cm **GAI239005**
60x75xh9 cm **GAI239006**
75x75xh9 cm **GAI239007**



CUSCINO SCHIENALE
backrest cushion

60x15xh28 cm **GAI239008**



COMPOSIZIONE LINEARE
linear configuration



COMPOSIZIONE AD ANGOLO
corner configuration

COMPOSIZIONI
CONFIGURATIONS



EMEROTECA, AMBIENTI INFORMALI

NEWSPAPER LIBRARY,
INFORMAL ENVIRONMENTS



POLTRONCINA KUARK
KUARK armchair

67x57xh44/78cm

GC0001326



CUSCINO REMOVIBILE E SFODERABILE
cushion with removable fabric

41x44 cm

GC0001327

KUARK KUARK

Poltronicina a pozzetto in polietilene non poroso, per utilizzo in interno e in esterno.
Disponibile in varie colorazioni, può essere dotata di cuscino removibile.

Tub armchair in non-porous polyethylene, for indoor and outdoor use.

Available in various upholsteries, it can be equipped with a removable seat cushion.



POLTRONA TONA CON SCHIENALE ALTO, BASE A 4 GAMBE IN FAGGIO NATURALE
TONA armchair with high backrest, natural beech 4-leg base

77x77xh42/110 cm

GU0002819



POLTRONA TONA CON SCHIENALE ALTO, BASE A 4 GAMBE IN FAGGIO VERNICIATO NERO
TONA armchair with high backrest, black beech 4-leg base

77x77xh42/110 cm

GU0002812

TONA TONA

Poltrona dalle linee morbide. Sedile interamente stampato in poliuretano schiumato a freddo. Struttura della scocca in acciaio. Lo schienale alto con risvolti laterali garantisce un ottimo comfort.

Armchair with a sinuous design. Seat entirely molded in cold-foamed polyurethane. Steel shell structure. The high backrest with side flaps offer an excellent comfort.



POLTRONA TONA CON SCHIENALE ALTO, BASE A SLITTA
TONA armchair with high backrest, sled base

77x77xh42/110 cm

GU0002803



**POLTRONA MIT CON SCHIENALE BASSO,
BASE A 4 GAMBE IN FAGGIO NATURALE**

MIT armchair with low backrest, natural
beech 4-leg base

80x82xh42/77 cm

GC0005602



**POLTRONA MIT CON SCHIENALE BASSO,
BASE A SLITTA**

MIT armchair with low backrest, sled base

80x82xh42/77 cm

GC0005355

MIT
MIT

**Poltrona disponibile con schienale
basso o alto, con gambe in faggio
naturale o con base a slitta.
Personalizzabile con tessuti
a contrasto tra scocca e cuscini.**

Armchair with low or high backrest,
on natural beech legs or sled base.
Customizable with contrasting fabrics.



**POLTRONA MIT CON SCHIENALE ALTO,
BASE A 4 GAMBE IN FAGGIO NATURALE**

MIT armchair with high backrest,
natural beech 4-leg base

80x82xh42/103 cm

GC0005606



**POLTRONA MIT CON SCHIENALE ALTO,
BASE A SLITTA**

MIT armchair with high backrest, sled base

80x82xh42/103 cm

GC0005354



EMEROTECA, AMBIENTI INFORMALI

NEWSPAPER LIBRARY,
INFORMAL ENVIRONMENTS



POLTRONA KENDO MONOCOLORE CON SCHIENALE BASSO E BRACCIOLI

KENDO armchair with low backrest,
one-color

78x69xh45/73 cm

GC0003868



POLTRONA KENDO BICOLORE CON SCHIENALE BASSO E BRACCIOLI

KENDO armchair with low backrest,
two-color

78x69xh45/73 cm

GC0003756

KENDO

KENDO

Sistema di sedute imbottite composto da poltrone e pouf, su base a 4 piedi in acciaio verniciato.

Le poltrone possono avere schienale basso o alto, con rivestimento monocolore o bicolore.

Tutti gli elementi possono essere accessoriati con doppia presa USB.

Upholstered seating system composed of armchairs and poufs, on painted steel legs. The armchairs can have a low or high backrest, with one-color or two-color upholstery. All elements can be equipped with a double USB socket.



POUF KENDO BICOLORE

KENDO POUF, two-color

67x63xh46 cm

GC0002559



POLTRONA KENDO BICOLORE CON SCHIENALE ALTO

KENDO armchair with high backrest,
two-color

90x73xh46/127 cm

GC0002558



SISTEMA DI CABLAGGIO KENDO/KONTEX CON DOPPIA PRESA USB

KENDO/KONTEX wiring system
with double USB socket

GC0005107



DIVANO KONTEX BICOLORE 2 POSTI

KONTEX two-seater sofa, two-color

140x70xh44/74 cm

GC0002803



COMPOSIZIONE KONTEX 2+2

KONTEX configuration 2+2

238x140xh128 cm

GC0003871

KONTEX

KONTEX

Divani disponibili con schienale basso o alto, con rivestimento monocolore o bicolore, con piedi di colore bianco.

Possono essere accessoriati con doppia presa USB.

Sofas with one-color or two-color upholstery, on white 4-foot base. All elements can be equipped with a double USB socket.



POLTRONCINA KUAD
KUAD armchair

65x56xh49/82 cm

GC0002303

KUAD
KUAD

Poltroncina con schienale flessibile, imbottito, con tessuto monocolore, con base a slitta.

Armchair with flexible backrest and one-color upholstery, on sled base.



POLTRONCINA KICCA PLUS
KIKKA PLUS armchair

53x57xh46/78 cm

GC0005692

KICCA PLUS
KICCA PLUS

Poltroncina monoscocca imbottita, con base a 4 gambe.

Upholstered monocoque armchair, 4-leg base.



TAVOLINO KALEOX TONDO
KALEOX round small table

Ø60xh40 cm bianco | white
Ø60xh40 cm nero | black

GC0000550
GC0003917



TAVOLINO KALEOX QUADRATO
KALEOX square small table

60x60xh40 cm bianco | white
60x60xh40 cm nero | black

GC0003916
GC0000609

KALEOX
KALEOX

Tavolini multiuso con base in acciaio e piano in HPL. Disponibili in colore bianco o nero.

Multipurpose small tables with steel base and HPL top. Available in white or black color.

EMEROTECA, AMBIENTI INFORMALI

NEWSPAPER LIBRARY,
INFORMAL ENVIRONMENTS



KENSHO KENSHO

Sistema di tavolini e pouf di forma triangolare arrotondata. I pouf sono disponibili con rivestimento monocolore o bicolore.

Small tables and poufs with rounded triangular shape. The poufs are available with one-color or two-color upholstery.



POUF KENSHO MONOCOLORE
KENSHO pouf, one-color

55/37xh51 cm **GC0005639**
65/70xh42 cm **GC0005640**
76/88xh42 cm **GC0005641**



POUF KENSHO BICOLORE
KENSHO pouf, two-color

55/37xh51 cm **GC0003862**
65/70xh42 cm **GC0003861**
76/88xh42 cm **GC0003911**



TAVOLINO KENSHO, BASE IN TONDINO
KENSHO small table, rod base

L/W53 45xh46 cm **GC0003336**
L/W53 45xh54 cm **GC0005388**



TAVOLINO KENSHO, BASE CIRCOLARE
KENSHO small table, round base

L/W53 Ø41xh46 cm **GU0000502**
L/W53 Ø41xh75 cm **GU0000503**
L/W80 Ø48xh75 cm **GC0002131**
L/W53 Ø48xh110 cm **GC0005389**
L/W70 Ø48xh110 cm **GU0001309**



POUF MANTRA
MANTRA pouf

Ø40xh45 cm **GC0005481**
Ø70xh45 cm **GC0005483**

MANTRA MANTRA

Pouf cilindrici di vari diametri, con struttura in legno, con piedini antiscivolo regolabili.

Cylindrical poufs of various diameters, with wooden structure and adjustable non-slip feet.

POINT
POINT

Pouf fondi dalla linea morbida, di vari diametri e altezze, con piedini regolabili.

Round poufs of various diameters and heights, with adjustable feet.



POUF POINT
POINT pouf

Ø58xh50 cm
Ø60xh43 cm
Ø85xh43 cm
Ø125xh43 cm

GC0005272
GC0005129
GC0005273
GC0005271

POINT Q
POINT Q

Pouf quadrati e rettangolari dalla linea morbida, di varie dimensioni, con piedini regolabili. Possono essere accessoriati con doppia presa USB.

Square poufs of various sizes, with adjustable feet. They can be equipped with a double USB socket.



POUF POINT Q
POINT Q pouf

45x45xh40 cm
90x45xh40 cm
90x45xh65 cm
90x90xh40 cm

GU0002030
GU0002031
GU0002032
GU0002033

SISTEMA DI CABLAGGIO CON 2 USB
wiring system with double USB socket

Ø4,2 cm

GU0002034

TRIO
TRIO

Grande pouf di forma trilobata, con struttura molto resistente e cuciture con supporti in fibra di carbonio.

Large three-lobed pouf, with a very resistant structure and internal supports in carbon fibre.



POUF TRIO
TRIO pouf

170x150xh44 cm

GC0005137

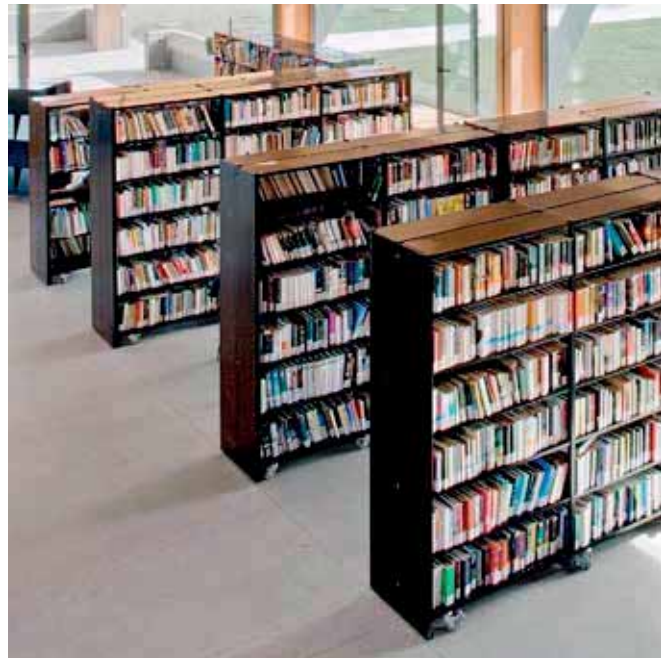



AMBIENTI PER CONSULTAZIONE, LETTURA, STUDIO

CONSULTATION, READING, STUDY AREAS

La biblioteca ha un cuore pieno di libri, trasmette il desiderio di leggere pagine di carta. Libri a fianco di dotazioni digitali, nella grande rete che lega mille biblioteche. La biblioteca è sempre un ponte tra conservazione e innovazione.

Ambienti moderni sostengono ogni forma di consultazione, lettura e studio. Lo spazio è organizzato in aree tematiche, flessibili, riconfigurabili. Gli arredi raccolgono ed espongono volumi e supporti multimediali. Sono disposti per definire ambiti protetti e aperti, formali e informali.

The library has a heart full of books, it conveys the desire to read paper pages.

Printed books and digital equipment together, in the great cultural network that connects thousands of libraries. The library is the bridge between conservation and innovation.

Modern environments promote consultation, reading and study.

The space is organized into thematic, reconfigurable areas.

The furnishings collect and display volumes and multimedia supports, defining formal and informal environments.

AMBIENTI PER
CONSULTAZIONE,
LETTURA, STUDIO

CONSULTATION,
READING, STUDY AREAS

SISTEMA MODULAR MODULAR SHELVING SYSTEM





MODULAR è il sistema base per organizzare libri, pubblicazioni e supporti multimediali. Scaffale tecnico interamente in acciaio, è modulare, funzionale, leggero, estremamente versatile.

MODULAR is the shelving system for organizing books, publications and multimedia supports. Entirely in steel, it is modular, functional, light, and extremely versatile.



PERSONALIZZAZIONI CUSTOMIZATIONS

Accessori tecnici, pannelli di rivestimento, complementi d'arredo, fanno del MODULAR un sistema aperto a infinite configurazioni.

Technical accessories, end panels, furnishing accessories make MODULAR shelving system suitable for countless configurations.

AMBIENTI PER CONSULTAZIONE, LETTURA, STUDIO

CONSULTATION,
READING, STUDY AREAS



ACCESSORI TECNICI

technical accessories

Espositori, cassette, contenitori, fermalibri, elementi di segnaletica.

Una serie completa di accessori tecnici rende lo scaffale MODULAR adatto a soddisfare le esigenze di ogni area della biblioteca.

Display units, drawers, cabinets, bookends, signage elements.

A complete set of technical accessories makes MODULAR shelving system suitable for meeting the needs of each library area.



Alla base dello scaffale MODULAR possono essere inserite ruote o zoccoli, frontali e laterali.

Front or side castors and plinths can be inserted at the base of the MODULAR shelf.

DIMENSIONI

SIZES

Moduli di varie larghezze, altezze e profondità consentono al sistema di rispondere a ogni esigenza.

Modules of various widths, heights and depths allow the system to respond to every need.

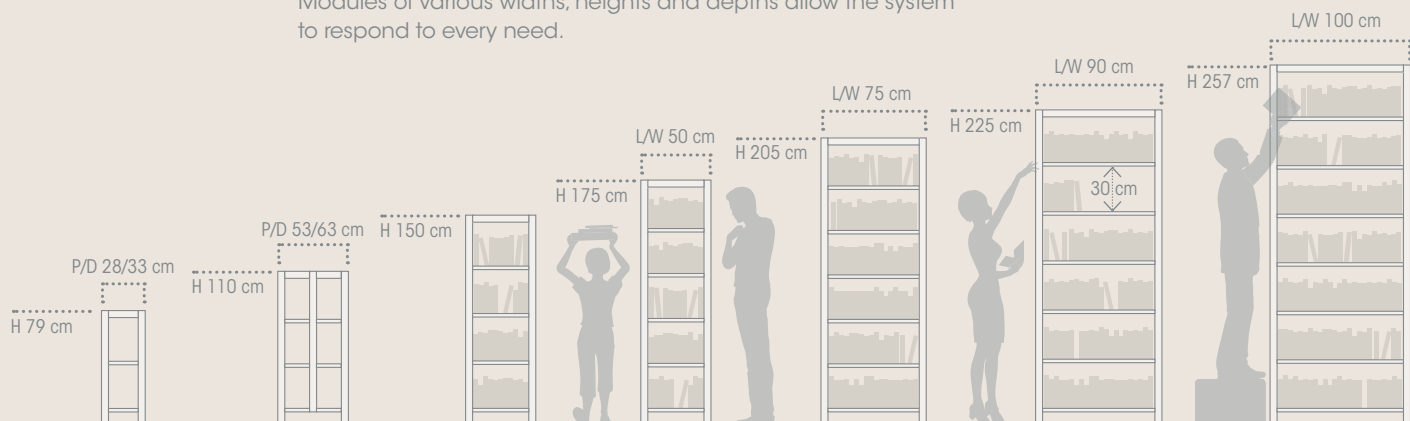

ACCESSORI PER FIANCHI

SIDE ACCESSORIES



ESPOSITORE IN PLEXIGLAS – GAM 7
plexiglas display stand – GAM 7

Tasca per l'esposizione di quotidiani e volumi di piccole dimensioni.

Display pocket for newspapers and small books.

GB0E00004



PIANO INCLINATO – GAM 8
inclined shelf – GAM 8

Espositore in metallo inclinato, per esporre frontalmente riviste e volumi, chiusi o aperti.

Inclined metal display to show magazines and volumes frontally, closed or open.

GB0E00001



PIANO ORIZZONTALE – GAM 9
horizontal display stand – GAM 9

Espositore orizzontale per volumi e supporti digitali.

Horizontal display stand for volumes and multimedia.

GB0E00002



ESPOSITORE PLURIUSO – GAM 5
multipurpose display stand – GAM 5

Elemento in tondino metallico cromato, per esporre pubblicazioni.

Display stand in chromed metal rod.

GB0E00010



ESPOSITORE UNIVERSALE PER LIBRI, GIORNALI, RIVISTE – GAM 6
book, newspapers and magazine display stand – GAM 6

Supporto multifunzione in tondino metallico cromato, utilizzabile in tre diverse posizioni: inclinata, orizzontale e a cestello.

Multipurpose display stand in chromed metal rod. It can be used in three different positions: inclined, horizontal and basket.

GB0E00011



AMBIENTI PER CONSULTAZIONE, LETTURA, STUDIO

CONSULTATION,
READING, STUDY AREAS

ACCESSORI PER RIPIANI

SHELF ACCESSORIES



**GANCIO PER INCLINAZIONE
DEI RIPIANI IN 5 POSIZIONI – GAM 2**
hook for shelf inclination – GAM 2

GB0S00002



CONTENITORE ESTRAIBILE
pull-out media drawer

Contenitore di supporti multimediali.

Pull-out media drawer.

L/W 90 P/D 25 cm
L/W 100 P/D 25 cm
L/W 90 P/D 30 cm
L/W 100 P/D 30 cm

GB0CCA004
GB0CDA004
GB0CCB004
GB0CDB004



**CONTENITORE ESPOSITORE
PER RIVISTE**
magazine box

Espositore per riviste.

Magazine box.

box riviste | magazine box
box quotidiani | newspaper box

GB0C00102
GB0C00302



ASTA SUPPORTO – GAM 1
support rod – GAM 1

**L'asta in metallo, che supporta tutti i ripiani,
può essere utilizzata come supporto
per gli accessori e come fermalibri laterale.**

The metal rod supports all shelves and can be
used to apply accessories or as side book support.

P/D 25 cm
P/D 30 cm

GB0S0A001
GB0S0B001



DOCK MULTIUSO
multipurpose dock

**Cassetto/espositore per CD, CD ROM
e DVD.**

CD, CD ROM and DVD dock/display.

GB0C00101



ESPOSITORE PLURIUSO – GAM 4
multipurpose display stand – GAM 4

Espositore in metallo.

Metal display stand.

GB0E00003

FERMALIBRI

BOOK SUPPORTS



FERMALIBRI A L

L-shaped book support

Può scorrere sul ripiano ed è disponibile nella versione destra e sinistra.

It slides along the shelf surface, available in both right and left version.

destro | right
sinistro | left

GB0F00001
GB0F00002



FERMALIBRI A PENDULO

suspended book support

25x22 cm
25x28 cm
30x22 cm
30x28 cm

GB0F0A103
GB0F0A203
GB0F0B103
GB0F0B203



SEPARATORE PER FERMALIBRI A PENDULO

partition for suspended book support

GB0F0A104

SEGNALETICA

SIGNAGE



50x50 cm
75x50 cm
90x50 cm
100x50 cm

GB0DA0001
GB0DB0001
GB0DC0001
GB0DD0001



GB0D00003

SEGNALETICA DI PIANO

front clip-on label for canopy

Si applica a incastro su ripiani e top del sistema MODULAR.

It can be fixed on all shelves and canopies of MODULAR system.



SEGNALETICA A BANDIERA

labelling flags

Il pannello è disponibile in forma rettangolare o tonda ed è personalizzabile con grafiche adesive o magnetiche.

The flag is available in rectangular or round shape and can be customized with adhesive or magnetic stickers.

GB0D00109

GB0D00209

GB0D00309



SEGNALETICA PER FIANCHI CON PROTEZIONE IN PLEXIGLAS

A4 polycarbonate sign panel for shelving side

Si applica a incastro sugli scaffali.

Clip-on application to the shelves.

A4
A3

GB0D00113
GB0D00213

AMBIENTI PER CONSULTAZIONE, LETTURA, STUDIO

CONSULTATION,
READING, STUDY AREAS



**PANNELLO LATERALE
IN METALLO FORATO**
perforated metal end panel



**PANNELLO LATERALE
IN TINTA UNITA**
solid color end panel



**PANNELLO LATERALE
IN LEGNO**
wooden end panel



**PANNELLO LATERALE
CON CORNICE IN LEGNO**
wooden end panel with frame



RIVESTIMENTI

end panels and tops

Pannelli laterali e top, in metallo o in legno, offrono un'alternativa all'aspetto tecnico ed essenziale del MODULAR. Si compongono scaffalature adatte ai più vari progetti di arredo.

Metal or wooden end panels and tops offer an alternative to the essential aspect of the MODULAR shelf. They make up shelf compositions suitable for the most varied design projects.

GRAFICHE

GRAPHICS

Scritte, loghi, grafiche, possono essere applicate ai pannelli laterali, per caratterizzare gli scaffali e dare informazioni agli utenti.

Words, logos, and images can be applied to end panels to identify the shelves and give information to library users.





ANTE IN LEGNO
wooden doors

**ANTE IN VETRO
CON CORNICE IN LEGNO**
glass doors with wooden frame

ANTE IN VETRO
glass doors

ANTE
doors

Ai moduli rivestiti si possono aggiungere ante, in legno o in vetro. Si compongono armadi MODULAR, per proteggere le pubblicazioni più preziose o delicate.

Wooden or glass doors can be added to the shelves making MODULAR cabinets to protect the most precious and fragile publications.



FIANCHI SPECIALI

SPECIAL END PANELS

Fianchi speciali comprendono piani di consultazione e sedute. Questi elementi possono essere coordinati con gli altri arredi della biblioteca.

Special end panels include consultation desks and seats.

These items can be coordinated with the other library furnishings.

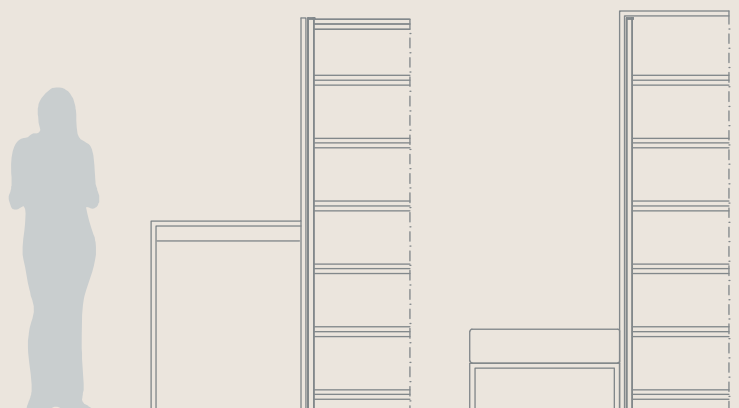

AMBIENTI PER CONSULTAZIONE, LETTURA, STUDIO

CONSULTATION,
READING, STUDY AREAS



MODULAR SPECIAL MODULAR SPECIAL

Complementi di arredo arricchiscono ulteriormente il SISTEMA MODULAR.

Contenitori, cassetti su ruote, panche, piani di lavoro e nicchie mono e bifronte, ampliano la funzione dello scaffale ben oltre il contenimento di libri.

Additional furnishing accessories enrich the MODULAR SHELVING SYSTEM. Cabinets, drawers on castors, benches, worktops, and single and double-sided niches increase the shelf's function.

DIMENSIONI

SIZES

I complementi della serie MODULAR SPECIAL hanno dimensioni coordinate con la modularità degli scaffali mono e bifronte.

The sizes of the MODULAR SPECIAL items are coordinated with the single and double-sided standard shelves.

H 205 cm

H 175 cm

H 100 cm

H 75 cm

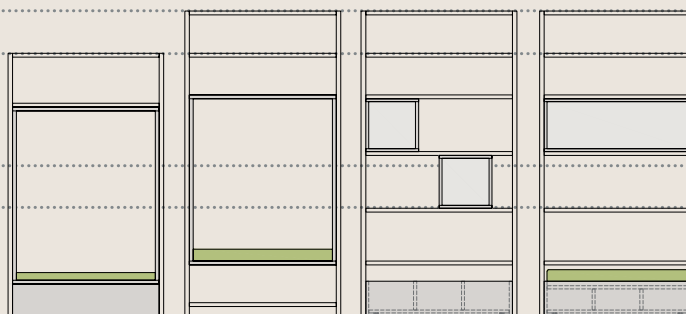



Elementi in legno naturale o con finitura colorata inseriti nella struttura metallica del MODULAR consentono molte composizioni e combinazioni cromatiche, che giocano sul rapporto tra i diversi materiali delle due famiglie di oggetti.

Elements in natural wood or in colored finish - inserted in the metal structure of the MODULAR shelf - allow many compositions and chromatic combinations.

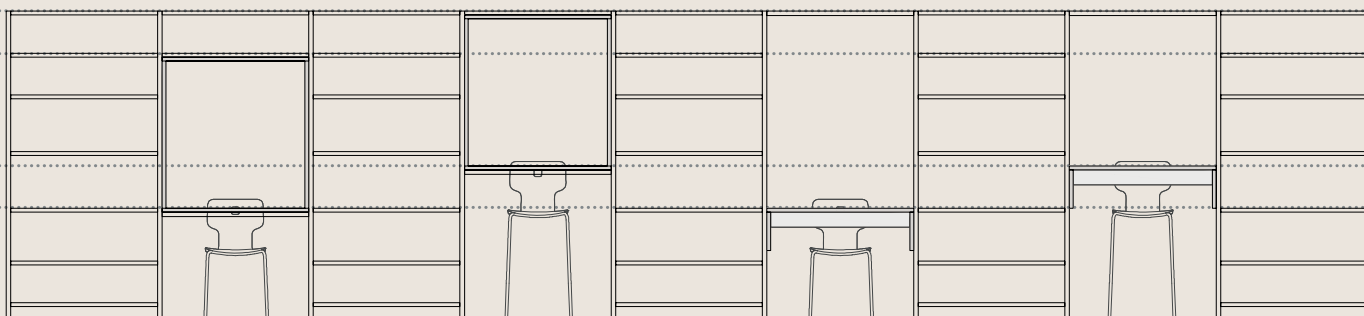

AMBIENTI PER
CONSULTAZIONE,
LETTURA, STUDIO

CONSULTATION,
READING, STUDY AREAS





BOX ESPOSITIVO QUADRATO
square box

35x30xh35 cm
35x35xh35 cm

GB0003557
GB0003556



BOX ESPOSITIVO RETTANGOLARE
rectangular box

87x30xh35 cm
97x30xh35 cm
87x35xh35 cm
97x35xh35 cm

GB0003274
GB0003077
GB0003273
GB0003076



CASSETTO SU RUOTE
drawer on castors

87x40xh26 cm
97x40xh26 cm

GV0003574
GV0003104



SEDUTA SU RUOTE
bench on castors

87x40xh37 cm
97x40xh37 cm

GV0003573
GV0003558



NICCHIA (MONOFRONTE E BIFRONTE)
reading pod
(single and double-sided)

87x30xh112,5 cm
97x30xh112,5 cm
87x33xh112,5 cm
97x33xh112,5 cm
87x53xh112,5 cm
97x53xh112,5 cm
87x63xh112,5 cm
97x63xh112,5 cm

GB1YCAA13
GB1YDAA13
GB1YCBA13
GB1YDBA13
GB1YCAA11
GB1YDAA11
GB1YCBA11
GB1YDBA11



NICCHIA A TERRA MONOFRONTE
ground reading pod
(single-sided)

87x33xh141,5cm
97x33xh141,5 cm
87x53xh141,5cm
97x53xh141,5 cm

GB1Y014SS
GB1Y008SS
GB1Y015SS
GB1Y016SS



TAVOLO-BOX
table-box

87x63xh100 cm
97x63xh100 cm
87x73xh100 cm
97x73xh100 cm

GB0L01005
GB0L01001
GB0L01006
GB0L01002



PIANO SCRITTOIO
worktop

87x63xh11,6 cm
97x63xh11,6 cm
87x73xh11,6 cm
97x73xh11,6 cm

GB0L01007
GB0L01003
GB0L01008
GB0L01004



AMBIENTI PER CONSULTAZIONE, LETTURA, STUDIO

CONSULTATION,
READING, STUDY AREAS



MODULAR CURVO CURVED MODULAR SHELF

**Il SISTEMA MODULAR comprende anche elementi curvi.
Scaffali bifronte che definiscono piccoli spazi avvolgenti.**

The MODULAR shelving system also includes curved elements.
Double-sided shelves that define small embracing spaces.

COMPOSIZIONI CONFIGURATIONS

MODULAR CURVO compone nicchie, anse, linee sinuose.

The CURVED MODULAR SHELF builds up niches and sinuous configurations.

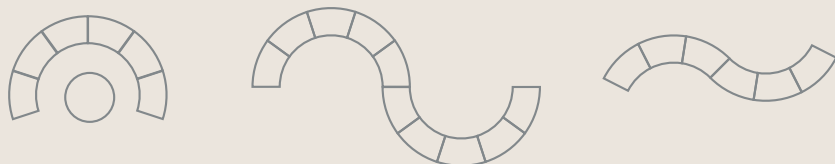

**Lo scaffale MODULAR CURVO
può essere montato su ruote.**

The CURVED MODULAR SHELF
can be mounted on castors.



Tratti curvilinei rompono la ripetizione di scaffalature lineari. Formano spazi concavi e convessi che rendono l'ambiente più vario e giocoso.

Curvilinear lines break up the repetition of linear shelving. They form concave and convex spaces that diversify the layout of the environment.

GEOMETRIE E DIMENSIONI

LAYOUT AND SIZES

I moduli curvi hanno un raggio interno di 100 cm e un'ampiezza corrispondente a un angolo di 36°. Cinque moduli compongono un semicerchio 200 cm di diametro interno e 306 cm di diametro esterno. Sono disponibili in due altezze.

The curved modules have an internal radius of 100 cm and a width corresponding to an angle of 36°. Five modules make up a semicircle with an internal diameter of 200 cm and an external diameter of 306 cm. They are available in two heights.

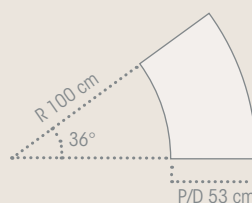

AMBIENTI PER
CONSULTAZIONE,
LETTURA, STUDIO

CONSULTATION,
READING, STUDY AREAS

SISTEMA EPIFANO EPIFANO SHELVING SYSTEM





EPIFANO è un sistema semplice e funzionale. Fianchi a pannello pieno in nobilitato supportano piani in lamiera d'acciaio. Il design essenziale è arricchito dalla dotazione di accessori.

EPIFANO is a simple and functional shelving system made of MFC end panels and steel sheet shelves. The essential design is enriched by the range of accessories.

DIMENSIONI

SIZES

Il SISTEMA EPIFANO comprende moduli mono e biface di cinque altezze e due larghezze.

EPIFANO SYSTEM includes single and double-sided shelves available in five heights and two widths.

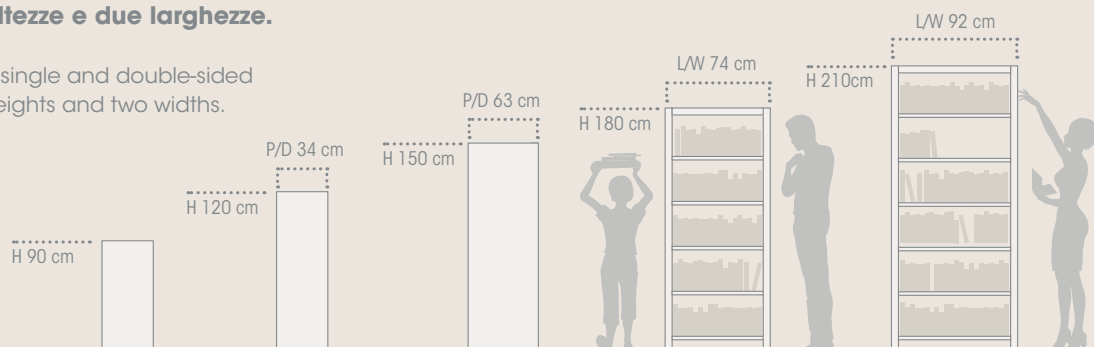

AMBIENTI PER
CONSULTAZIONE,
LETTURA, STUDIO

CONSULTATION,
READING, STUDY AREAS



ANTE
doors

EPIFANO può essere dotato di ante, basse o alte, in legno o in vetro.

EPIFANO shelf can be equipped with high or low doors, in wood or glass.



FIANCO ESPOSITORE
side display

Al fianco di testata dello scaffale bifronte può essere fissato uno speciale modulo espositore.

A special display module can be fixed to the side of the double-sided shelf.

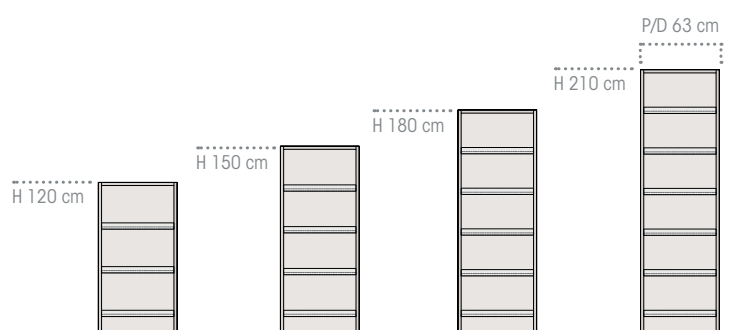

Alla base dello scaffale EPIFANO possono essere inserite ruote o zoccoli frontali.

Castors or front plinths can be inserted at the base of the EPIFANO shelf.

ACCESSORI PER FIANCHI

SIDE ACCESSORIES



PIANO DI CONSULTAZIONE

fixed consultation shelf

GB6R00450

ACCESSORI PER RIPIANI

SHELF ACCESSORIES



ESPOSITORE TRE VANI PER RIVISTE

3-compartment magazine display box

87x38xh36 cm
coppia staffe | brackets

GB6E02831
GB6R01430



CONTENITORE ESTRAIBILE

pull-out media drawer

87x25 cm

GB0CCA009

Su EPIFANO è possibile usare anche gli accessori MODULAR:

It is also possible to use the MODULAR accessories on EPIFANO shelf:

- DOCK MULTIMEDIALE

multipurpose dock
GB0C00101

- ESPOSITORE PLURIUSO – GAM 4

multipurpose display stand – GAM 4
GB0E00003

- ESPOSITORE PLURIUSO – GAM 5

multipurpose display stand – GAM 5
GB0E00010

FERMALIBRI

BOOK SUPPORT



FERMALIBRO A MEZZALUNA

semicircular book support

GB0F00106

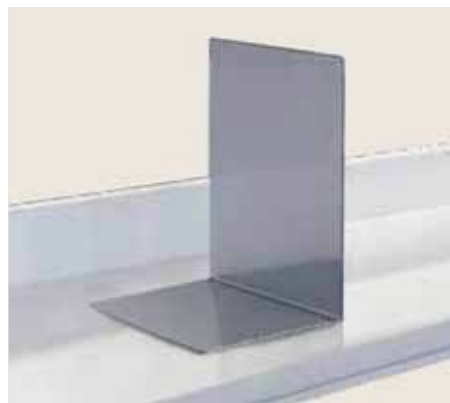

FERMALIBRO A L

L-shaped book support

GB4M10251

SEGNALETICA

SIGNAGE



GB0D00411



SEGNALETICA DI PIANO

front clip-on label for canopy

GB0E00115

AMBIENTI PER
CONSULTAZIONE,
LETTURA, STUDIO

CONSULTATION,
READING, STUDY AREAS

ESPOSITORI PER LIBRI E SUPPORTI DIGITALI BOOK AND MULTIMEDIA DISPLAY UNITS





SISTEMA INSERT
INSERT SYSTEM

Sistema per realizzare librerie con box espositivi e altri accessori. Contenitori a giorno o chiusi, con ante o cassetti, si inseriscono nei vani dello scaffale per comporre mosaici di vari materiali e colori.

Modular system to create bookcases with display boxes and other accessories. Open or closed cabinets, with doors or drawers, fit into the shelf compartments to compose mosaics of various materials and colors.



SCAFFALE INSERT
INSERT bookcase

169x40xh197 cm

G1VI0092N



SCHIENALE
back

80xh45 cm

G1VI0195N



BOX FILL
FILL box

40x38xh45 cm
40x38xh45 cm

G1VI0194L
G1VI0194N



CONTENITORE A GIORNO FILL
FILL open cabinet

40x40xh45 cm
40x40xh45 cm
80x40xh45 cm
80x40xh45 cm

G1VI0179L
G1VI0179N
G1VI0086L
G1VI0086N



CASSETTIERA FILL
FILL drawer unit

80x40xh45 cm
80x40xh45 cm

G1VI0084L
G1VI0084N



CONTENITORE CON ANTE FILL
FILL cabinet with doors

40x40xh45 cm destro | right
40x40xh45 cm destro | right
40x40xh45 cm sinistro | left
40x40xh45 cm sinistro | left
80x40xh45 cm
80x40xh45 cm

G1VI0181L
G1VI0181N
G1VI0180L
G1VI0180N
G1VI0088L
G1VI0088N

AMBIENTI PER
CONSULTAZIONE,
LETTURA, STUDIO

CONSULTATION,
READING, STUDY AREAS



ESPOSITORE A SCHEDARIO
9-compartment book browser

96x60xh90 cm

GB0000414



**ESPOSITORE A SCHEDARIO
CON TRE VANI VERTICALI**
15-compartment book browser

96x60xh90 cm

GB0000415



ESPOSITORE CASSETTO SU RUOTE
9-compartment drawer on castors

90x60xh30 cm

GB0000416



ESPOSITORE A SCHEDARIO CON CASSETTO

BOOK BROWSER WITH DRAWER

**Il cassetto su ruote può essere
inserito nell'espositore o essere
usato separatamente.**

The drawer can be placed in the book
browser or used separately.





**ESPOSITORE A SCHEDARIO
CON TRE VANI VERTICALI SU RUOTE**
15-compartment book browser cart

96x60xh75 cm

GB0000413



ESPOSITORE A SCHEDARIO SU RUOTE
8-compartment book browser cart

60x60xh60 cm
60x60xh80 cm

GV0001661
GV0001662



**ESPOSITORE A SCHEDARIO
CON STRUTTURA METALLICA**
9-compartment book browser on metal frame

96x60xh75 cm

GV0002705



**ESPOSITORE A SCALARE
CON STRUTTURA METALLICA**
book browser on metal frame – for display
and storage

96x60xh100 cm

GV0001788

AMBIENTI PER
CONSULTAZIONE,
LETTURA, STUDIO

CONSULTATION,
READING, STUDY AREAS

TAVOLI PER CONSULTAZIONE E LETTURA CONSULTATION AND READING TABLES





TAVOLO IDEA+
IDEA+ table

80x60xh76 cm
100x60xh76 cm
120x60xh76 cm
140x60xh76 cm
160x60xh76 cm
180x60xh76 cm

GU0000216
GU0000217
GU0000510
GU0000501
GU0000470
GU0000219



80x80xh76 cm
100x80xh76 cm
120x80xh76 cm
140x80xh76 cm
160x80xh76 cm
180x80xh76 cm

GU0000111
GU0000237
GU0000486
GU0000239
GU0000164
GU0000243

IDEA+
IDEA+

Tavoli con gambe a cavalletto distaccate dal piano. Disponibili in varie larghezze, con profondità monofronte o bifronte. Possono essere usati come tavoli di lettura o come tavoli per riunioni.

Tables with trestle legs detached from the tabletop. Available in various widths and depths. They can be used as reading tables or as meeting tables.



TAVOLO IDEA+ DOPPIO
IDEA+ double table

140x124xh76 cm
160x124xh76 cm

GC0005624
GC0005625

ACCESSORI
ACCESSORIES



TOP ACCESS
top access

3 prese UNEL
4 prese UNEL
3 prese UNEL e 2 prese USB
2 prese UNEL e 2 prese rete RJ45

GB0000263
GB0000274
GB0000308
GB0000260



TOP ACCESS DUAL
top access dual

3 prese UNEL
4 prese UNEL
3 prese UNEL e 2 prese USB
4 prese UNEL e 2 prese rete RJ45

GB0000272
GB0000278
GB0000269
GB0000273



LAMPADA A PONTE
table lamp

Lampada led 35W 3000°K

Led lamp 35W 3000°K

160 cm

GC0005235

AMBIENTI PER
CONSULTAZIONE,
LETTURA, STUDIO

CONSULTATION,
READING, STUDY AREAS



**TAVOLO RIUNIONE QUADRATO,
BASE CUBO**
square meeting room table, cube base

140x140xh76,8 cm

GU0000643

TAVOLI RIUNIONE
meeting room tables

**Tavoli con piano di superficie ampia.
Di varie forme e dimensioni,
con strutture diversamente
caratterizzate.**

Tables with large tops.
Available in various shapes and sizes.



TAVOLO RIUNIONE RETTANGOLARE
rectangular meeting room table

210x100xh76 cm

GU0000644



TAVOLO RIUNIONE OVALE
oval meeting room table

200x110xh76 cm

GU0000648



TAVOLO ALTO
high table

120x80xh100 cm
140x80xh100 cm
160x80xh100 cm
180x80xh100 cm

GPN903900
GPN903901
GPN903902
GPN903903

TAVOLI ALTI
high tables

**Tavoli da utilizzare stando in piedi
o seduti su sgabelli.**

To be used while standing or sitting
on stools.



TAVOLO POP-UP
POP-UP table

120x70xh75 cm
140x70xh75 cm
160x70xh75 cm
180x70xh75 cm

GU0002748
GU0002274
GU0002747
GU0002832



120x80xh75 cm
140x80xh75 cm
160x80xh75 cm
180x80xh75 cm

GU0002262
GU0002263
GU0002264
GU0002265

POP-UP
POP-UP

Tavoli con struttura metallica su ruote e piano in legno ribaltabile. Per un uso flessibile, di semplice spostamento e stoccaggio. Possono essere dotati di ganci per unire i piani frontalmente e lateralmente.

Tables with metal structure on castors and folding wooden top, to ensure easy movement and storage. They can be equipped with hooks to join the tabletops frontally and laterally.



TAVOLO TONDO CON GAMBONE
round table with central leg

Ø100xh76 cm
Ø120xh76 cm

GU0000273
GU0000037



TAVOLO KAPIO QUADRATO
KAPIO square table

70x70xh75 cm

GC0003227

TAVOLI CON GAMBA CENTRALE
tables with central leg

Tavoli tondi o quadrati, in legno e metallo o interamente in metallo. Aspetto informale e facilità d'uso con sedie di ogni tipo.

Round or square tables, in wood and metal or entirely in metal. Informal look and ease of use with all kind of chairs.



AMBIENTI PER CONSULTAZIONE, LETTURA, STUDIO

CONSULTATION,
READING, STUDY AREAS



96,5x60xh64 cm
86,5x60xh75 cm
96,5x60xh75 cm

GBORDA044
GBORDA025
GBORDA026



86,5x60xh100 cm
96,5x60xh100 cm

GBORDA027
GBORDA028

CONSOLLE

console

**Tavolo per consultazione
o per postazione multimediale.
Disponibile in due larghezze
e due altezze.**

Table to be used for consultation
or as multimedia station.
Available in two widths and two heights.



60xh105 cm
60xh130 cm

GBORDA047
GBORDA048

PANNELLO DIVISORIO

divider panel

**Schermo per proteggere spazi
di lavoro individuali.**

Divider panel to delimit individual
workspaces.

COMPOSIZIONI

CONFIGURATIONS

**Le CONSOLLE possono essere inserite
all'interno di scaffali MODULAR
da 90 e 100 cm.**

The CONSOLE can be inserted inside
the cm 90 and 100 long MODULAR shelves.





POSTAZIONE OPAC CON ANTA
OPAC fixed workstation with CPU cabinet

70x63xh107,5 cm

GB0L00203



**POSTAZIONE OPAC FISSA
CON PIANO ANTICADUTA**
OPAC fixed workstation with anti-fall protection

70x59xh107,5 cm
con | with box CPU
con | with consolle CPU

GB0L00101
GB0L00201
GB0L00301



**POSTAZIONE OPAC REGOLABILE
ELETTRICA CON PIANO ANTICADUTA**
OPAC height-adjustable workstation with anti-fall protection

70x59xh67/110,5 cm

GB0L00105



**POSTAZIONE OPAC FISSA
CON PIANO SAGOMATO**
OPAC fixed workstation with top integrated case

70x59xh107,5 cm
con | with box CPU
con | with consolle CPU

GB0L00401
GB0L00501
GB0L00601



**POSTAZIONE OPAC REGOLABILE
ELETTRICA CON PIANO SAGOMATO**
OPAC height-adjustable workstation with top integrated case

70x59xh67/110,5 cm

GB0L00305

POSTAZIONI OPAC

OPAC WORKSTATIONS

Le postazioni OPAC si differenziano per il disegno del piano e per le caratteristiche della gamba, ad altezza fissa o regolabile.

Le postazioni a gamba fissa possono essere dotate di alloggiamento per PC, aperto in metallo o chiuso in legno.

The OPAC workstations differ in the design of the top and in the characteristics of the leg, with fixed or adjustable height. The fixed workstations can be equipped with a metal or wooden CPU holder.

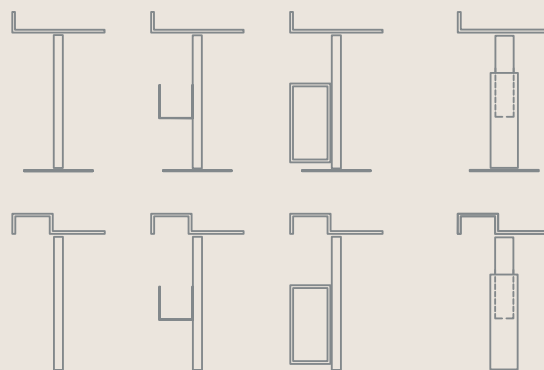

AMBIENTI PER
CONSULTAZIONE,
LETTURA, STUDIO

CONSULTATION,
READING, STUDY AREAS

SEDUTE LETTURA E MULTIUSO MULTIPURPOSE AND READING CHAIRS





SEDIA KALEA CON SEDUTA IMBOTTITA, BICOLORE, BASE A 4 GAMBE

KALEA chair with upholstered seat, two-color, 4-leg base

52x53xh46/80 cm

GC0002554



SEDIA KALEA CON SEDUTA E SCHIENALE IMBOTTITI, BICOLORE, BASE A 4 GAMBE

KALEA chair with upholstered seat and backrest, two-color, 4-leg base

52x53xh46/80 cm

GC0002711

KALEA
KALEA

Sedie e sgabelli, mono o bicolori, con basi a 4 gambe, a slitta e a 4 ruote. Seduta e schienale possono essere imbottiti. Tutti i modelli sono impilabili.

Chairs and stools available one-color or two-color, with 4-leg, sled or 4-caster base. Seat and back can be upholstered. All models are stackable.



SEDIA KALEA BICOLORE, BASE A 4 GAMBE

KALEA chair, two-color, 4-leg base

52x53xh46/80 cm

GC0001808



SEDIA KALEA BICOLORE, CON TAVOLETTA SCRITTOIO ANTIPANICO, BASE A 4 GAMBE

KALEA chair with tilting tablet, two-color, 4-leg base

60x72xh46/73/80 cm

GC0002730



SEDIA KALEA BICOLORE, BASE A SLITTA

KALEA chair, two-color, sled base

52x53xh46/80 cm

GC0002129



SEDIA KALEA BICOLORE, GIREVOLE, BASE A 4 RAZZE SU RUOTE

KALEA swivel chair, two-color, 4-caster base

46x53xh46/81 cm

GC0005678



SGABELLO KALEA BICOLORE, BASE A 4 GAMBE CON POGGIAPIEDI

KALEA stool, two-color, 4-leg base with footrest

52x53xh72/107 cm

GC0002335



CARRELLO PORTASEDIE KALEA

trolley for KALEA chairs

GC0000544

AMBIENTI PER CONSULTAZIONE, LETTURA, STUDIO

CONSULTATION,
READING, STUDY AREAS



SEDIA CLOP, BASE A 4 GAMBE
CLOP chair, 4-leg base

58x58xh44/84cm

GC0005687



SEDIA CLOP, BASE A SLITTA
CLOP chair, sled base

58x58xh44/84cm

GC0005688

CLOP CLOP

**Poltroncina monoscocca
in polipropilene rinforzato.
Disponibile con sedile imbottito.**

Monocoque polypropylene chair.
Available with upholstered seat.



**SEDIA CLOP CON SEDUTA IMBOTTITA,
BASE A 5 RAZZE SU RUOTE**
CLOP chair with upholstered seat,
5-caster base

65x68xh40/53 cm

GC0005689



TAVOLETTA SCRITTOIO
tablet

GC0005690



**SEDIA KLIA, CON E SENZA BRACCIOLI,
BASE A 4 GAMBE**
KLIA chair, 4-leg base

46x56xh46/80 cm

GC0005679

57x54xh46/80 cm braccioli | armrests **GC0005680**



CARRELLO PORTASEDIE KLIA
trolley for KLIA chairs

GC0000544

KLIA KLIA

**Sedia monoblocco in polipropilene
rinforzato con fibra di vetro.
Entrambe le versioni sono impilabili.**

Monobloc chair in polypropylene
reinforced with glass fibre.
Both versions are stackable.



SEDIA KICCA, BASE A 4 GAMBE
KICCA chair, 4-leg base

54x55xh46/76 cm

GC0000654



SEDIA KICCA, BASE A SLITTA
KICCA chair, sled base

54x55xh46/76 cm

GC0000561

KICCA
KICCA

Sedie e sgabelli monoscocca in polipropilene. Le sedie con base a 4 gambe e a slitta sono impilabili.

Polypropylene monocoque chairs and stools. The chairs with 4-leg and sled base are stackable.



SEDIA KICCA, BASE 4 RAZZE SU RUOTE
KICCA chair, 4-caster base

54x55xh46/76 cm

GC0005681



SEDIA KICCA, BASE 5 RAZZE SU RUOTE
KICCA chair, 5-caster base

54x55xh43/55 cm

GC0001975



SGABELLO KICCA, BASE AD ALTEZZA REGOLABILE
KICCA stool, height-adjustable base

47x55xh56/81 cm

GC0005682



AMBIENTI PER
CONSULTAZIONE,
LETTURA, STUDIO

CONSULTATION,
READING, STUDY AREAS

ARREDI FONOASSORBENTI SOUND-ABSORBING FURNISHINGS





PANNELLI FONOASSORBENTI

sound-absorbing panels

Pannelli in molte forme e colori, da montare a parete o a soffitto. Riducono il riverbero e migliorano il comfort acustico degli ambienti.

Panels in many shapes and colors, to be mounted on the wall or ceiling. They reduce reverberation and improve acoustic comfort in the rooms.



PANNELLO SOLUTION

SOLUTION PANEL

Pannelli PHONOLOOK monofacciali con spigoli ad angolo vivo, rivestiti in tessuto ignifugo.

PHONOLOOK single-sided panels with sharp corners, covered in fireproof fabric



PANNELLO DESIGN

DESIGN PANEL

Pannelli PHONOLOOK bifacciali con finitura perimetrale, rivestiti in tessuto ignifugo.

PHONOLOOK double-sided panels with perimeter finish, covered in fireproof fabric.

		SOLUTION spessore 50 mm	DESIGN spessore 50 mm
□	60x60 cm	GP0903000	GP0903100
	120x120 cm	GP0903001	GP0903101
▭	120x30 cm		GP0903104
	180x30 cm		GP0903105
	120x60 cm	GP0903002	GP0903106
	180x60 cm	GP0903003	GP0903107
○	180x120 cm	GP0903004	
○	Ø60 cm	GP0903011	GP0903114
	Ø100 cm	GP0903012	GP0903115

KIT FISSAGGIO A PARETE/SOFFITTO PHONOLOOK

PHONOLOOK panel – wall/ceiling fixing kit _____ **GP0903013**

KIT CAVI IN ACCIAIO PER SOSPENSIONE PANNELLI PHONOLOOK SOLUTION **

PHONOLOOK SOLUTION panel – steel cable suspension kit ** _____ **GP0903014**

KIT CAVI IN ACCIAIO PER SOSPENSIONE PANNELLI PHONOLOOK DESIGN ***

PHONOLOOK DESIGN panel – steel cable suspension kit *** _____ **GP0903015**

** per posa orizzontale rispetto al soffitto
for horizontal installation from the ceiling

*** per posa orizzontale e verticale rispetto al soffitto
for horizontal and vertical installation from the ceiling

AMBIENTI PER CONSULTAZIONE, LETTURA, STUDIO

CONSULTATION,
READING, STUDY AREAS



PANNELLI FONOASSORBENTI RETROSCAFFALE

rear shelf sound-absorbing panels

Pannelli fonoassorbenti da fissare con magneti alla struttura degli scaffali MODULAR. Disponibili in molti colori, individuano spazi di lettura e di consultazione con ottimo comfort acustico.

Sound-absorbing panels to be fixed with magnets to the structure of the MODULAR shelves. Available in many colors, they define reading and consultation spaces with excellent acoustic comfort.



PANNELLO FONOASSORBENTE RETROSCAFFALE

rear shelf sound-absorbing panel

87xh149,5 cm	GC0005718
97xh149,5 cm	GC0005716
87xh174,5 cm	GC0005719
97xh174,5 cm	GC0005717



PANNELLO FONOASSORBENTE RETROSCAFFALE ANGOLO

rear shelf sound-absorbing panel – corner

85xh149,5 cm	GC0005722
95xh149,5 cm	GC0005720
85xh174,5 cm	GC0005723
95xh174,5 cm	GC0005721



PANNELLO RETROSCAFFALE IN METALLO FORATO

rear shelf perforated metal panel

87xh149,5 cm	GB1P058SS
97xh149,5 cm	GB1P056SS
87xh174,5 cm	GB1P059SS
97xh174,5 cm	GB1P057SS



RIPIANO ANGOLORE IN METALLO

corner metal shelf

90° p/d 25 cm	GB0R004SS
90° p/d 30 cm	GB0R003SS

COMPOSIZIONI CONFIGURATIONS

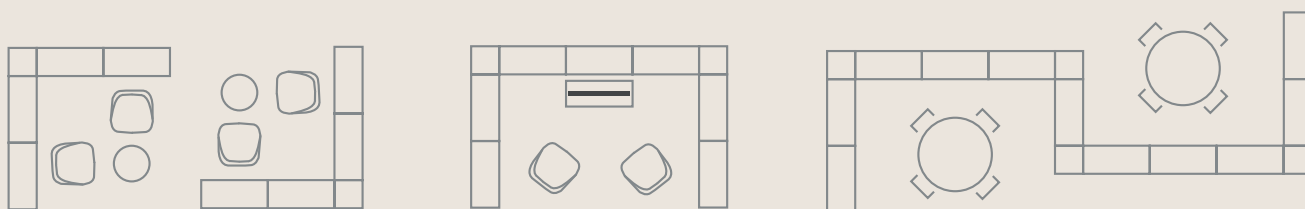



TENDE FONOASSORBENTI
sound-absorbing curtains

Tende in tessuto fonoassorbente, da agganciare a binari lineari o curvilinei. Definiscono spazi raccolti e confortevoli, per lettura informale o incontri.

Curtains in sound-absorbing fabric, to be hooked to linear or curved tracks. They define cozy and comfortable spaces for informal reading or meetings.



COMPOSIZIONE LINEARE
linear configuration

220xh300 cm

GC0005726



COMPOSIZIONE RETTANGOLARE
rectangular configuration

300x220xh300 cm

GC0005725



COMPOSIZIONE TONDA
round configuration

Ø320xh300 cm

GC0005724

COMPOSIZIONI
CONFIGURATIONS

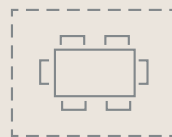
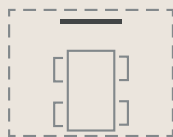





SPAZI PER RAGAZZI E BAMBINI

CHILDREN AND TEENS ENVIRONMENTS

La biblioteca è amica dei più giovani. Accende il loro interesse e lo alimenta. Propone occasioni uniche, che non trovano neppure a scuola.

Per i ragazzi è una grande finestra sul mondo e attraverso il tempo. Posto dove concentrarsi da soli e luogo d'incontro e socializzazione.

Ai bambini si offre come spazio a loro misura, di racconto e di scoperta. Anche come laboratorio dove sperimentare.

I più piccoli trovano ambiti accoglienti, protetti e sicuri. Cominciano a conoscere e ad amare i libri, prima di imparare a leggere.

The library is a friend to the youngest, it fuels their interest in reading and offers unique learning opportunities.

For kids, it's a great window into the world and through time.

A place to concentrate but also a place to meet and socialize.

Children find a space tailored to them, a place for storytelling and discovery. The library is also a laboratory in which to experiment.

The little ones find welcoming, protected, and safe environments.

They begin to know and love books before learning to read.

SPAZI
PER RAGAZZI
E BAMBINI

CHILDREN AND TEENS
ENVIRONMENTS

SCAFFALI, ESPOSITORI, CONTENITORI SHELVES, DISPLAYS, CABINETS





MODULAR KIDS

MODULAR KIDS

Il sistema più versatile sa interpretare gli ambienti per i più giovani. Lo scaffale tecnico è anche a misura dei bambini. Diventa amichevole e gioioso.

Ripiani inclinati, contenitori e sedute su ruote, pannelli con grafiche, arredano spazi funzionali e informali.

The most versatile shelving system must interpret environments for the youngest and be suitable for children. The shelf gets friendly and playful. Inclined shelves, cabinets and seats on castors and panels with graphics furnish functional and informal spaces.



BOX ESPOSITIVO QUADRATO

square box

35x30xh35 cm
35x35xh35 cm

GV0003557
GV0003556



BOX ESPOSITIVO RETTANGOLARE

rectangular box

87x30xh35 cm
97x30xh35 cm
87x35xh35 cm
97x35xh35 cm

GV0003274
GV0003077
GV0003273
GV0003076



CASSETTO SU RUOTE

drawer on castors

87x40xh26 cm
97x40xh26 cm

GV0003574
GV0003104



SEDUTA SU RUOTE

bench on castors

87x40xh37 cm
97x40xh37 cm

GV0003573
GV0003558

SPAZI PER RAGAZZI E BAMBINI

CHILDREN AND TEENS
ENVIRONMENTS



SISTEMA 618 – CONTENITORI

SYSTEM 618 – cabinets

Contenitori non solo per libri.
Moduli di varie altezze e larghezze, aperti o chiusi ad ante,
compongono un sistema ricco e flessibile. La gamma colori
consente di realizzare molte combinazioni cromatiche.

Cabinets not only for books.
Modules of various heights and widths – open or with doors –
make up a rich and flexible cabinet system.
The wide color range allows to create many different combinations.

ANGOLO

CORNER

**Un modulo a giorno funziona come elemento
angolare del sistema.**

**Consente di realizzare composizioni
freestanding per suddividere e articolare
grandi ambienti.**

An open module works as the corner element of the system.
It allows to build freestanding compositions to split large
rooms into smaller spaces.



L/W 45 cm

COLONNA 2 CASELLE

2-compartment column
H 91 cm



su piedi
on feet **GPN600800**

senza piedi
without feet **GPN600801**

su ruote
on castors **GPN600802**

COLONNA 3 CASELLE

3-compartment column
H 129 cm



su piedi
on feet **GPN601900**

senza piedi
without feet **GPN601901**

su ruote
on castors **GPN601902**

COLONNA 4 CASELLE

4-compartment column
H 168 cm



su piedi
on feet **GPN603200**

CONTENITORE A CASELLE
open compartment cabinet
H 91 cm
H 79 cm senza piedi | without feet

CONTENITORE AD ANTE
door cabinet
H 91 cm
H 79 cm senza piedi | without feet

CONTENITORE A CASELLE
open compartment cabinet
H 129 cm
H 117 cm senza piedi | without feet

CONTENITORE AD ANTE
door cabinet
H 129 cm
H 117 cm senza piedi | without feet

CONTENITORE A CASELLE
open compartment cabinet
H 168 cm

CONTENITORE AD ANTE
door cabinet
H 168 cm

L/W 80 cm



su piedi
on feet **GPN600300**
senza piedi
without feet **GPN600301**
su ruote
on castors **GPN600302**



su piedi
on feet **GPN600500**
senza piedi
without feet **GPN600501**
su ruote
on castors **GPN600502**



su piedi
on feet **GPN601300**
senza piedi
without feet **GPN601301**
su ruote
on castors **GPN601302**



su piedi
on feet **GPN601500**
senza piedi
without feet **GPN601501**
su ruote
on castors **GPN601502**



su piedi
on feet **GPN602300**



su piedi
on feet **GPN602500**

L/W 120 cm



su piedi
on feet **GPN610300**
senza piedi
without feet **GPN610301**
su ruote
on castors **GPN610302**



su piedi
on feet **GPN610500**
senza piedi
without feet **GPN610501**
su ruote
on castors **GPN610502**



su piedi
on feet **GPN611300**
senza piedi
without feet **GPN611301**
su ruote
on castors **GPN611302**



su piedi
on feet **GPN611500**
senza piedi
without feet **GPN611501**
su ruote
on castors **GPN611502**



ZOCCOLO
plinth

45x45x12 cm **GPN615020**

80x45x12 cm **GPN615021**

120x45x12 cm **GPN615022**

ELEMENTO BASE | BASE CABINET

L/W 80 cm



su piedi
on feet **GPN620000**
senza piedi
without feet **GPN620001**
su ruote
on castors **GPN620002**



su piedi
on feet **GPN620008**
su ruote
on castors **GPN620009**

L/W 120 cm



su piedi
on feet **GPN620100**
senza piedi
without feet **GPN620101**
su ruote
on castors **GPN620102**



su piedi
on feet **GPN620114**
su ruote
on castors **GPN620115**

ELEMENTO BASE
base cabinet
H 31 cm
H 19 cm senza piedi | without feet

ELEMENTO BASE
base cabinet
H 44 cm

SPAZI PER RAGAZZI E BAMBINI

CHILDREN AND TEENS
ENVIRONMENTS



SISTEMA 618 – ACCESSORI

SYSTEM 618 – accessories

Casellari, espositori, fioriere, lavagne, appendiabiti, sedute, nicchie e microspazi.

Una serie di accessori amplia la funzionalità del sistema, per definire spazi ben caratterizzati.

Filing cabinets, displays, planters, blackboards, hangers, seats, niches and micro-spaces.

The accessories expand the functionality of the system to set up well-characterized spaces.

DIMENSIONI

SIZES

Accessori e pezzi speciali si inseriscono nella griglia dimensionale del sistema.

Size chart for accessories and special items.

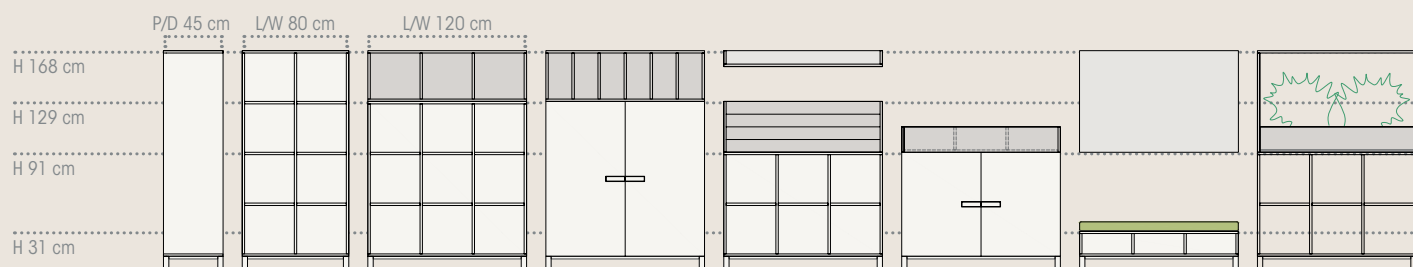



TOP A CASELLE
cubby top

80x45xh38 cm
120x45xh38 cm

GPN620400
GPN620500



TOP A CASELLE
cubby top

80x45xh38 cm
120x45xh38 cm

GPN620401
GPN620501



TOP ESPOSITORE
display top

80x45xh38 cm
120x45xh38 cm

GPN620402
GPN620502



TOP ESPOSITORE ORIZZONTALE
horizontal display top

80x45xh19 cm
120x45xh19 cm

GPN620403
GPN620503



TOP FIORIERA
flower box top

80x45xh77 cm
120x45xh77 cm

GPN620405
GPN620505



TOP LAVAGNA
writing board top

80x45xh77 cm
120x45xh77 cm

GPN620406
GPN620506



MENSOLA
shelf

80x25xh15 cm
120x25xh15 cm

GPN620408
GPN620508



CUSCINO
cushion

80x45xh7 cm
120x45xh7 cm

GAI239002
GAI239001



CUBO MORBIDO
cube soft seating

36x36xh36 cm

GPN620700



**VANO MULTIUSO
CON SCHIENALE FORATO**
multipurpose compartment –
back with holes

80x45xh98 cm
80x45xh137 cm
120x45xh98 cm
120x45xh137 cm

GPN620006
GPN620007
GPN620106
GPN620107



PUNTO E VIRGOLA
PUNTO e VIRGOLA

PUNTO
PUNTO E VIRGOLA

GPN620601
GPN620600



COCOON
cocoon reading pod

120x45xh137 cm

GPN620104



NICCHIA CON CUSCINI
reading pod with cushions

160x60xh168 cm
materasso compreso
mat included

GPN620110
GAI000215



NICCHIA CON TAVOLINO
reading pod with table

190x60xh168 cm
materasso compreso
mat included

GPN620112
GAI000216



MICROSPAZIO
microspace

190x190xh190 cm
materasso compreso
mat included

GPN620122
GAI000217

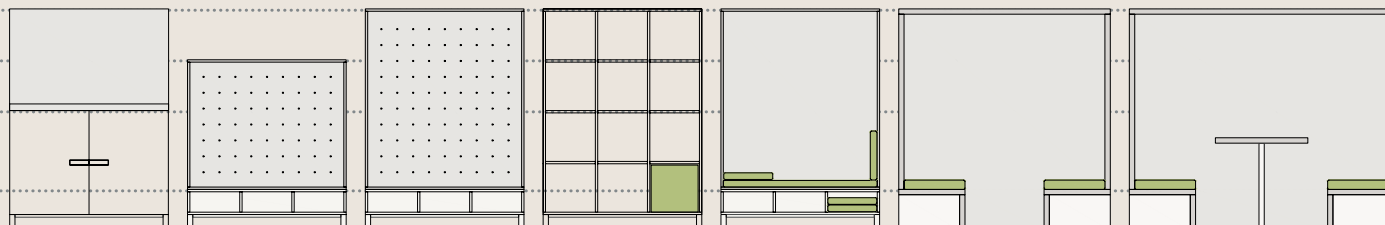

SPAZI PER RAGAZZI E BAMBINI

CHILDREN AND TEENS
ENVIRONMENTS



SISTEMA 618 – MODULI CURVI

SYSTEM 618 – curved cabinets

Contenitori curvilinei compongono nicchie, isole, linee sinuose. Definiscono spazi concavi e convessi.

Contenitori e sedute coordinate formano piccoli ambienti riparati, per lettura, incontri, relax.

Curvilinear cabinets make up niches, islands, sinuous lines. They define concave and convex spaces.

Coordinated cabinets and seats form cozy areas for reading, meeting, relaxing.



DIMENSIONI







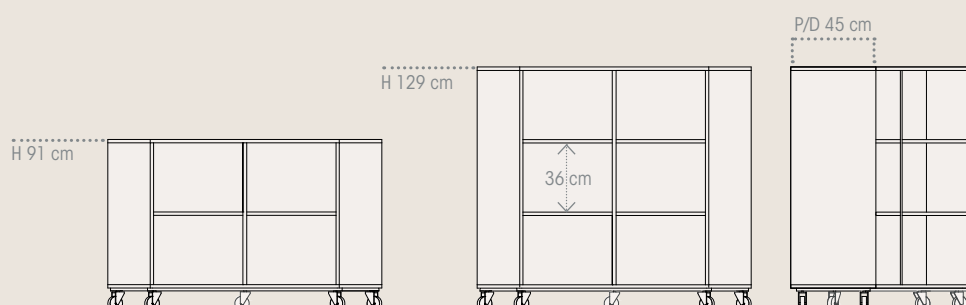



SIZES

I contenitori curvilinei sono disponibili in due altezze coordinate con i contenitori lineari.

Curved cabinets are available in two heights, coordinated with the straight modules.



CONTENITORE A CASELLE CURVO
 curved cabinet
H 91 cm
H 79 cm senza piedi | without feet

R 100-145 cm				
su piedi on feet				
	GPN614000	GPN614100	GPN614200	GPN614300
senza piedi without feet				
	GPN614001	GPN614101	GPN614201	GPN614301
su ruote on castors				
	GPN614002	GPN614102	GPN614202	GPN614302

CONTENITORE A CASELLE CURVO
 curved cabinet
H 129 cm
H 117 cm senza piedi | without feet

su piedi on feet				
	GPN614400	GPN614500	GPN614600	GPN614700
senza piedi without feet				
	GPN614401	GPN614501	GPN614601	GPN614701
su ruote on castors				
	GPN614402	GPN614502	GPN614602	GPN614702

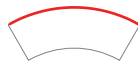

La base dei contenitori è un telaio metallico su piedi o su ruote.

The base of the cabinets is a metal frame with feet or castors.

TELAIO SU PIEDI
 base on feet

GPN615003

TELAIO SU RUOTE
 base on castors

GPN615004

SEDUTE CURVILINEE | CURVED SEATS



R55-100x45xh38 cm **GPN616104**
 R65-100x35xh38 cm **GPN616100**
 R55-100x45xh44 cm **GPN616107**
 R65-100x35xh44 cm **GPN616108**



R100-145x45xh38 cm **GPN616101**
 R100-145x45xh44 cm **GPN616109**



R145-190x45xh38 cm **GPN616102**
 R145-190x45xh44 cm **GPN616110**



Ø90xh38 cm **GPN616103**
 Ø90xh44 cm **GPN616111**

SPAZI
PER RAGAZZI
E BAMBINI

CHILDREN AND TEENS
ENVIRONMENTS

TAVOLI E SEDUTE TABLES AND CHAIRS





SISTEMA 618 – TAVOLI
SYSTEM 618 – tables

Tavoli diversi, per forma, dimensione, struttura e accessori, rispondono a molteplici esigenze. Per tanti usi, per grandi e piccoli, in ogni ambiente della biblioteca.

Different tables in terms of shape, size, structure and accessories, respond to multiple needs. Suitable for adults and children, they fit multiple uses in any library setting.



TAVOLO STUDIO 1
study table 1

165x60xh75 cm
165x60xh100 cm

GPN600200
GPN600201



TAVOLO STUDIO 2
study table 2

165x60xh75 cm
165x60xh100 cm

GPN600205
GPN600206



TAVOLO STUDIO 3
study table 3

165x60xh75 cm
165x60xh100 cm

GPN600210
GPN600211



CONTENITORE SOPRAPIANO
countertop unit

60x45xh38 cm

GPN600220



TAVOLO REGOLABILE SU CAVALLETTI
height-adjustable table on trestles

220x80xh75-90 cm

GC0003502

SPAZI PER RAGAZZI E BAMBINI

CHILDREN AND TEENS
ENVIRONMENTS

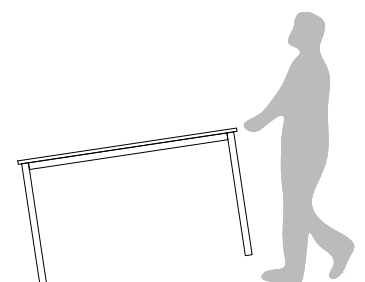

TAVOLI SU RUOTE

tables on castors

Ruote inserite al piede di due gambe facilitano lo spostamento.

Invisible castors inserted at the ends of two legs facilitate movement.

TAVOLI IMPILABILI

stackable tables

Tavoli quadrati, rettangolari e tondi sono disponibili anche in versione impilabile con due o quattro gambe esterne al piano.

Square, rectangular, and round tables are available also in stackable version with two or four legs external to the tabletop.



TAVOLO QUADRATO
square table



TAVOLO RETTANGOLARE
rectangular table



TAVOLO ROTONDO
round table

	FISSO FIXED	SU RUOTE ON CASTORS	IMPILABILE STACKABLE	IMPILABILE SU RUOTE STACKABLE ON CASTORS
65x65xh58 cm	GPN900103	GPN900133	GPN900123	GPN900163
65x65xh64 cm	GPN900104	GPN900134	GPN900124	GPN900164
65x65xh70 cm	GPN900105	GPN900135	GPN900125	GPN900165
65x65xh76 cm	GPN900106	GPN900136	GPN900126	GPN900166
80x80xh58 cm	GPN900203	GPN900233	GPN900223	GPN900263
80x80xh64 cm	GPN900204	GPN900234	GPN900224	GPN900264
80x80xh70 cm	GPN900205	GPN900235	GPN900225	GPN900265
80x80xh76 cm	GPN900206	GPN900236	GPN900226	GPN900266
130x130xh58 cm	GPN900303	GPN900333	GPN900323	GPN900363
130x130xh64 cm	GPN900304	GPN900334	GPN900324	GPN900364
130x130xh70 cm	GPN900305	GPN900335	GPN900325	GPN900365
130x130xh76 cm	GPN900306	GPN900336	GPN900326	GPN900366
140x80xh58 cm	GPN901103	GPN901133	GPN901123	GPN901163
140x80xh64 cm	GPN901104	GPN901134	GPN901124	GPN901164
140x80xh70 cm	GPN901105	GPN901135	GPN901125	GPN901165
140x80xh76 cm	GPN901106	GPN901136	GPN901126	GPN901166
160x80xh58 cm	GPN901203	GPN901233	GPN901223	GPN901263
160x80xh64 cm	GPN901204	GPN901234	GPN901224	GPN901264
160x80xh70 cm	GPN901205	GPN901235	GPN901225	GPN901265
160x80xh76 cm	GPN901206	GPN901236	GPN901226	GPN901266
Ø100xh58 cm	GPN901603	GPN901633	GPN901623	GPN901663
Ø100xh64 cm	GPN901604	GPN901634	GPN901624	GPN901664
Ø100xh70 cm	GPN901605	GPN901635	GPN901625	GPN901665
Ø100xh76 cm	GPN901606	GPN901636	GPN901626	GPN901666
Ø130xh58 cm	GPN901803	GPN901833	GPN901823	GPN901863
Ø130xh64 cm	GPN901804	GPN901834	GPN901824	GPN901864
Ø130xh70 cm	GPN901805	GPN901835	GPN901825	GPN901865
Ø130xh76 cm	GPN901806	GPN901836	GPN901826	GPN901866



SISTEMA 06 – TAVOLI
SYSTEM 06 – tables

Per i bambini sono disponibili tavoli in legno con gambe cilindriche e bordi arrotondati. Anche uno speciale tavolo basso, da usare stando seduti per terra.

Wooden tables with cylindrical legs and rounded edges are available for children. There is also a special low table, to be used while sitting on the floor.



TAVOLO QUADRATO IN LEGNO
square wooden table

75x75xh40 cm	GA0240100
75x75xh46 cm	GA0240201
75x75xh53 cm	GA0240202
75x75xh59 cm	GA0240203
75x75xh76 cm	GA0240206



TAVOLO RETTANGOLARE IN LEGNO
rectangular wooden table

150x75xh40 cm	GA0241200
150x75xh46 cm	GA0241201
150x75xh53 cm	GA0241202
150x75xh59 cm	GA0241203
150x75xh76 cm	GA0241206



TAVOLO ROTONDO IN LEGNO
round wooden table

Ø90xh40 cm	GA0242800	Ø128xh40 cm	GA0243000
Ø90xh46 cm	GA0242801	Ø128xh46 cm	GA0243001
Ø90xh53 cm	GA0242802	Ø128xh53 cm	GA0243002
Ø90xh59 cm	GA0242803	Ø128xh59 cm	GA0243003
Ø90xh76 cm	GA0242806	Ø128xh76 cm	GA0243006



TAVOLO GIAPPONESE
japanese table

100x100xh30 cm	GV0003126
----------------	------------------



CUSCINO
cushion

30x30xh7 cm	GA1000153
-------------	------------------

SPAZI PER RAGAZZI E BAMBINI

CHILDREN AND TEENS
ENVIRONMENTS



SEDIA G-TYPE SU 4 GAMBE
G-TYPE chair on 4 legs

h34 cm
h34 cm faggio | beech
h38 cm
h38 cm faggio | beech
h42 cm
h42 cm faggio | beech
h46 cm
h46 cm faggio | beech

GPN907303
GPN907403
GPN907304
GPN907404
GPN907305
GPN907405
GPN907306
GPN907406



SEDIA G-TYPE SU RUOTE
G-TYPE chair on castors

h38/46 cm
h38/46 cm faggio | beech
h42/50 cm
h42/50 cm faggio | beech

GPN907600
GPN907700
GPN907602
GPN907702



SGABELLO G-TYPE
G-TYPE stool

h70 cm

GPN907800



G-TYPE

G-TYPE

G-TYPE è la nuova sedia ideata da GAM e prodotta in collaborazione con la capogruppo iMilani. È un progetto originale, sviluppato con il contributo di competenze specialistiche, per trovare la miglior sintesi di estetica, funzionalità, qualità produttiva. G-TYPE è disponibile in cinque colori e in legno compensato curvato, su quattro gambe, su slitta cantilever o a cinque razze su ruote. I modelli su gambe e slitta sono impilabili. Con finitura antracite è disponibile nella versione in plastica riciclata o ignifuga in CL1. Il design è di Giovanni Fumagalli e Claudio Gorgi.

G-Type is the new chair designed by GAM and produced in collaboration with the parent company iMilani. This peculiar project, developed through specialized skills, aims to find the best synthesis of aesthetics, functionality, production quality.

G-Type chair is available in five colors and in curved natural plywood. The base can be on four legs, cantilever or with five castors. The legs and cantilever models are stackable. The anthracite shell is also available in CL1 fireproof recycled plastic. The design is by Giovanni Fumagalli and Claudio Gorgi.



SEDIA POSTURA
POSTURA chair

h34 cm
h38 cm
h42 cm
h46 cm

GA0247113
GA0247114
GA0247115
GA0247116



SEGGIOLINA IN LEGNO IMPILABILE
stackable wooden chair

30x25,5xh26/54 cm
32x28xh31/60 cm
32x32xh35/67 cm
34,5x34xh38/71 cm
38x40xh46/83 cm

GA0246901
GA0246902
GA0246903
GA0246904
GA0246906

SEDIE
chairs

Sedie in plastica e in legno, impilabili, a misura dei bambini.

Plastic and wooden chairs, stackable, suitable for children.



SEGGIOLINA PLURIPÌÙ
PLURIPÌÙ chair

36x31,4xh31,4 cm
seduta | seat h16/21 cm
riduttore | reducer

GA0245800
GA0245801



PLURIPÌÙ è una seggiola pluriuso per bambini da 0 a 3 anni. Tre posizioni e tre altezze di seduta. I fori e i bottoni sui fianchi consentono anche di realizzare scaffali e divisori.

PLURIPÌÙ is a multipurpose chair for children aged 0 to 3 years. Three positions and three seat heights. The holes and buttons on the sides also allow to make shelves and dividers.



SGABELLO TURIN
TURIN stool

h42/55 cm
h60/72 cm

GC0003873
GU0002769



SGABELLO FISSO IN LEGNO
fixed wooden stool

27x27xh25 cm
27x27xh30 cm
36x36xh45 cm

GA0247311
GA0247312
GA0247315

SGABELLI
stools

Sgabelli ad altezza regolabile con struttura metallica, per spazi laboratoriali, e in legno impilabili, per ogni ambiente.

Height-adjustable stools with metal structure for laboratories, and stackable wooden ones for any environment.

SPAZI
PER RAGAZZI
E BAMBINI

CHILDREN AND TEENS
ENVIRONMENTS

PEZZI SPECIALI SPECIAL ITEMS





CASAMIA BIBLIO
CASAMIA BIBLIO

CASAMIA BIBLIO è una biblioteca minima. Pannello libreria, panca contenitore, pouf, cuscini e tappeto, fanno del classico microspazio GAM un piccolo luogo speciale, dedicato al primo incontro dei bambini con i libri.

CASAMIA BIBLIO is a mini-library. Library-panel, display bench, pouf, cushions, and carpet turn GAM micro-space into a cozy place dedicated to the children's first encounters with books.



SPAZI PER RAGAZZI E BAMBINI

CHILDREN AND TEENS
ENVIRONMENTS



CASAMIA
CASAMIA

185x115xh185 cm
185x228xh185 cm
185x340xh185 cm

GA0264000
GA0264001
GA0264002



TELO BIANCO
white canvas sheet

208xh107 cm

GA0264010



SEDUTA CONTENITORE
container bench

105x27,5xh22 cm

GA0264012



PANNELLO PORTALIBRI
book display panel

105xh55 cm

GA0264013



SEDUTA MORBIDA LINEARE
linear padded bench

105x27,5xh22 cm

GAI000156



POUF
pouf

Ø30xh22 cm

GAI000155



CUSCINO
cushion

Ø30xh4 cm

GAI000157



SEDUTA MORBIDA A ELLE
L-shaped padded bench

105x30/70xh8 cm

GAI000154



SCHIENALE
padded backrest

105xh55 cm

GAI000158



TAPPETO
carpet

185x110 cm

GA0286243



GREEN CASAMIA
GREEN CASAMIA

Portavasi e griglie vestono CASAMIA come un microspazio verde. Piccolo laboratorio di coltivazione, serra senza vetri, rifugio per bambini che vogliono appartarsi con le piante.

Potholders and grids transform CASAMIA into a green micro-space. Small cultivation laboratory, glassless greenhouse, shelter for children who want to discover plants.

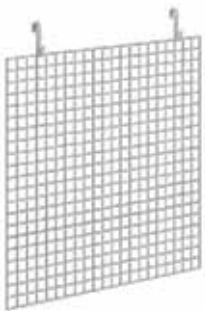

GRIGLIA PORTAVASI
potholder grid

105xh105 cm

GA0266064



PANNELLO PORTAVASI
potholder panel

105xh55 cm

GA0266063



ALBERO DEI VASI
pot tree

Ø100xh123 cm
Ø100xh143 cm

GA0241525
GA0241526

SPAZI PER RAGAZZI E BAMBINI

CHILDREN AND TEENS
ENVIRONMENTS

PEDANE, POUF, MORBIDI PLATFORMS, POUFS, SOFT FURNISHINGS





PEDANE E QUADRI
platforms and squares

Pedane ed elementi quadrati e rettangolari, in tre altezze, realizzano composizioni a gradoni. Quadri espositori e a pannello completano sulle pareti l'allestimento di spazi informali versatili.

Platforms, and square and rectangular elements in three heights create stepped compositions. Wall displays and panels complete the setting up of versatile informal spaces.



PEDANA QUADRATA
square platform

80x80xh19 cm **GP0909210**
80x80xh38 cm **GP0909211**
80x80xh57 cm **GP0909212**
160x160xh19 cm **GP0909215**



PEDANA RETTANGOLARE
rectangular platform

160x80xh19 cm **GP0909220**



CONTENITORE
storage box

80x80xh19 cm **GP0909225**
80x80xh38 cm **GP0909226**



PEDANA PORTAVASI
potholder platform

80x80xh19 cm **GP0909235**
80x40xh57 cm **GP0909229**
80x40xh100 cm **GP0909282**



CUSCINO PEDANA
cushion

40x40xh3 cm **GP0909230**
40x80xh3 cm **GP0909231**
80x80xh3 cm **GP0909232**



PANNELLO A PARETE
wall panel

80x80 cm **GP0909428**
160x80 cm **GP0909429**



PANNELLO PORTALIBRI A PARETE
wall book display

80x80xh8 cm **GP0909436**



CONTENITORE A PARETE
wall display

80x80xh19 cm **GP0909430**

SPAZI PER RAGAZZI E BAMBINI

CHILDREN AND TEENS
ENVIRONMENTS



ESAGONI

hexagons

Forte impronta geometrica per composizioni aperte. Sistema di pedane, sedute e pannelli per realizzare ambiti informali.

Strong geometric imprint for open compositions. Platforms, seats and panels to create informal settings.



PANNELLO A PARETE
wall panel

96x83,1 cm

GP0909400



PANNELLO TRAPEZOIDALE A PARETE
trapezoidal wall panel

96x41,6 cm

GP0909401



ESPOSITORE A PARETE
wall display

96x83,1xh24 cm
96x83,1xh32 cm

GP0909402
GP0909403



ESPOSITORE TRAPEZOIDALE A PARETE
trapezoidal wall display

96x41,6xh24 cm
96x41,6xh32 cm

GP0909404
GP0909405



ESPOSITORE ORIZZONTALE
horizontal display

96x83,1xh24 cm
96x83,1xh32 cm

GP0909406
GP0909407



ESPOSITORE ORIZZONTALE ALTO
high horizontal display

96x83,1xh48 cm
96x83,1xh56 cm
96x83,1xh64 cm

GP0909408
GP0909409
GP0909410



PEDANA TRAPEZIODALE
trapezoidal platform

96x41,6xh16 cm
96x41,6xh24 cm
96x41,6xh32 cm
96x41,6xh48 cm

GP0909411
GP0909412
GP0909413
GP0909414



PEDANA
platform

96x83,1xh16 cm
96x83,1xh24 cm
96x83,1xh32 cm
96x83,1xh48 cm

GP0909415
GP0909416
GP0909417
GP0909418



SEDUTA MORBIDA TRAPEZOIDALE
trapezoidal soft seating

96x41,6xh32 cm
96x41,6xh48 cm

GP0909419
GP0909420



SEDUTA MORBIDA
soft seating

96x83,1xh32 cm
96x83,1xh48 cm

GP0909423
GP0909424



CUSCINO
cushion

96x83,1xh8 cm

GP0909422



TAPPETO
carpet

96x83,1 cm

GP0909421



GRADONI E PANCHE

two-tiered seatings and benches

Gradoni e panche componibili arredano spazi per incontri, presentazioni, dibattiti.

Two-tiered seatings and modular benches furnish spaces for meetings, presentations, debates.



GRADONE
two-tiered seating

105x70xh76 cm
105x105xh76 cm

GPN909201
GPN909200



GRADONE ANGOLO
corner two-tiered seating

105x105xh76 cm **GPN909203**



PANCA
bench

80x45xh38 cm
120x45xh38 cm
180x45xh38 cm

GP0909102
GP0909101
GP0909100



PANCA CON VANO
bench with open compartment

120x45xh38 cm **GP0909111**
180x45xh38 cm **GP0909110**



ANGOLO
corner element

45x45xh38 cm
cablato con torretta
with powerdock

GP0909003
GP0909103



PANCHETTO
small bench

40x40xh35 cm **GP0909120**



CASSETTO SU RUOTE
drawer unit on castors

40x40xh33 cm **GP0909121**



CUSCINO
cushion

34x34xh3 cm **GP0909230**

SPAZI PER RAGAZZI E BAMBINI

CHILDREN AND TEENS
ENVIRONMENTS



SISTEMA 06 – POUF

SYSTEM 06 – poufs

Pouf di varie geometrie e dimensioni, tutti componibili, con gambe cilindriche in legno. SPECIAL O e SPECIAL X sono sedute particolari, aggregabili a incastro.

Modular poufs of various shapes and sizes, with cylindrical wooden legs. SPECIAL O and SPECIAL X are seats that can be joined together.



SMARTIPOUF
SMARTIPOUF

Ø50xh24 cm
Ø80xh42 cm

GAI223001
GAI223000



SMARTIPOUF FLAT
SMARTIPOUF flat

Ø50xh24 cm
Ø80xh42 cm

GAI223003
GAI223002



POUF TRIANGOLARE
triangular pouf

50x45xh35 cm

GAI223004



POUF TONDO
round pouf

Ø50xh35 cm

GAI223005



POUF QUADRATO
square pouf

50x50xh35 cm
75x75xh35 cm

GAI223006
GAI223008



POUF RETTANGOLARE
rectangular pouf

100x50xh35 cm

GAI223007



POUF SPECIAL O
POUF SPECIAL O

Ø120xh35 cm

GAI223009



POUF SPECIAL X
POUF SPECIAL X

135x135xh35 cm

GAI223010



SISTEMA 618 – POUF
SYSTEM 618 – poufs

Pouf con struttura metallica coordinati ai contenitori del SISTEMA 618. Moduli curvi e LUNA compongono linee sinuose.

Pouf with metal structure coordinated with the cabinets of SYSTEM 618. Curved modules and LUNA make sinuous compositions.



POUF QUADRATO
square pouf

45x45xh38 cm
80x80xh38 cm
45x45xh44 cm
80x480xh44 cm

GPN616200
GPN616201
GPN616202
GPN616203



POUF RETTANGOLARE
rectangular pouf

80x45xh38 cm
120x45xh38 cm
80x45xh44 cm
120x45xh44 cm

GPN616204
GPN616205
GPN616206
GPN616207



POUF CURVO
curved pouf

R100x45xh38 cm
R100x45xh44 cm

GPN616208
GPN616211



POUF TONDO
round pouf

Ø80xh38 cm
Ø80xh44 cm

GPN616209
GPN616212



POUF LUNA
half-moon pouf

Ø80xh38 cm
Ø80xh44 cm

GPN616210
GPN616213

COMPOSIZIONI
CONFIGURATIONS

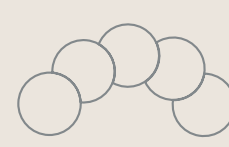
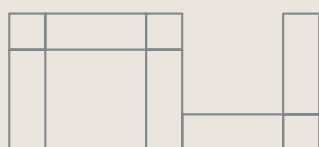

SPAZI PER RAGAZZI E BAMBINI

CHILDREN AND TEENS
ENVIRONMENTS



POUF poufs

Pouf di geometrie più complesse arricchiscono l'offerta di sedute informali per bambini e ragazzi.

Poufs with complex geometries enrich the offer of informal seating for children and teenagers.



DELTA
DELTA

85x43,5x30 cm
85x43,5x42 cm

GAI292201
GAI292178



BETA
BETA

150x80x42 cm

GAI292179



TETA
TETA

170x52x30 cm
170x52x42 cm

GAI292202
GAI292180



ZETA
ZETA

85x43,5x42 cm

GAI292181



ALFA
ALFA

50x43,5x42 cm

GAI292182



OMEGA
OMEGA

50x50x42 cm

GAI292184



KAPPA
KAPPA

97x55x30 cm
97x55x42 cm

GAI292203
GAI292185



SIGMA
SIGMA

165x150x42 cm
Ø50x42 cm

GAI292187
GAI292186



TAPPETO IN TREFORD treford carpet

150x150 cm
150x200 cm
200x200cm
200x300 cm
Ø150 cm
Ø200 cm
170x50 cm

GA0286400
GA0286401
GA0286402
GA0286403
GA0286404
GA0286405
GA0286406



TAPPETO IN MOQUETTE moquette carpet

150x150 cm
150x200 cm
200x200cm
200x300 cm
Ø150 cm
Ø200 cm

GA0286200
GA0286201
GA0286202
GA0286203
GA0286204
GA0286205



MORBIDI
soft furnishings

Per piccoli e piccolissimi, arredi morbidi per arredare spazi confortevoli e sicuri.

Soft furnishings for babies and toddlers, to furnish comfortable and safe spaces.



CUSCINO MONOCOLORE
one-color cushion

40x40 cm **GAI206000**
60x60 cm **GAI206100**



CUSCINO BICOLORE
two-color cushion

120x120 cm **GAI206200**
Ø90 cm **GAI206600**
Ø120 cm **GAI206700**



ABBRACCIO MORBIDO
cosy cuddle

50x50xh20 cm **GAI209600**



ABBRACCIO APPOGGIO
cosy support

50x50x15/20xh18 cm **GAI209500**



PIANO QUADRATO
square surface

60x60xh13 cm **GAI217000**
60x60xh26 cm **GAI217100**
60x60xh39 cm **GAI217200**



POUF QUADRATO
square pouf

50x50xh24 cm **GAI215300**
50x50xh30 cm **GAI215301**
60x60xh42 cm **GAI215302**

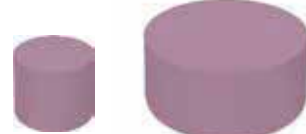

POUF ROTONDO
round pouf

Ø40xh24 cm **GAI213000**
Ø40xh30 cm **GAI213100**
Ø40xh42 cm **GAI213200**
Ø60xh32 cm **GAI227300**
Ø60xh42 cm **GAI213203**



SET ARCOBALENO
rainbow set

Ø60 cm **GAI203700**



ECLISSE S
ECLISSE S

Ø120xh40 cm **GAI223301**



SACCOTTO
beanbag

55x55xh85 cm **GAI225200**
95x80xh90 cm **GAI225201**

SPAZI
PER RAGAZZI
E BAMBINI

CHILDREN AND TEENS
ENVIRONMENTS

SISTEMA PARETE WALL SYSTEM





Pannelli modulari in vari materiali, con una serie di accessori, arredano le pareti. Lavagne, mensole, piani di lavoro, contenitori ed espositori, fissati su superfici verticali, moltiplicano gli spazi della biblioteca.

Modular panels in various materials furnish the walls.
Blackboards, shelves, worktops, cabinets and displays multiply the library spaces.

DIMENSIONI

SIZES

Le dimensioni degli elementi del sistema sono coordinate con quelle dei contenitori. L'altezza complessiva è uguale a quella del contenitore H 168 con sovrapposto un TOP A CASELLE.

The sizes of the wall items are coordinated with those of the cabinets.
The overall height is cm 206 (like a cabinet cm 168h with a CUBBY TOP).

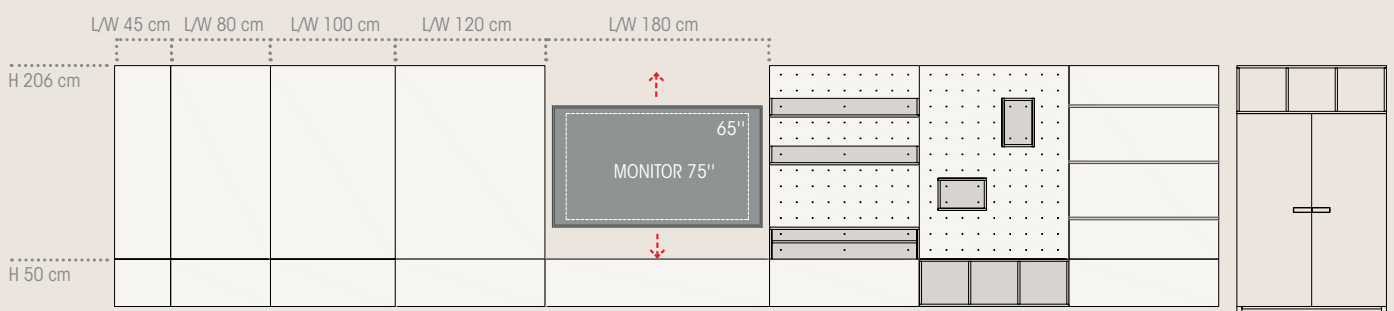

SPAZI PER RAGAZZI E BAMBINI

CHILDREN AND TEENS
ENVIRONMENTS



PANNELLO IN LEGNO **
wooden wall panel **

45xh156 cm
80xh156 cm
100xh156 cm
120xh156 cm

GP0941000
GP0941001
GP0941004
GP0941002

**** DISTANZIATORE IN LEGNO**
wooden spacer

GV0003759



PANNELLO IN LEGNO FORATO **
wooden wall panel with holes **

45xh156 cm
80xh156 cm
100xh156 cm
120xh156 cm

GP0942200
GP0942201
GP0942204
GP0942202



PANNELLO IN SUGHERO **
cork wall panel **

45xh156 cm
80xh156 cm
120xh156 cm

GP0941400
GP0941401
GP0941402



PANNELLO IN LAMINATO BIANCO **
white HPL wall panel **

45xh156 cm
80xh156 cm
120xh156 cm

GP0941200
GP0941201
GP0941202



PANNELLO IN LAMINATO LAVAGNA **
black HPL writing board wall panel **

45xh156 cm
80xh156 cm
120xh156 cm

GP0941600
GP0941601
GP0941602



PANNELLO FONOASSORBENTE **
sound-absorbing wall panel **

45xh156 cm
80xh156 cm
120xh156 cm

GP0942000
GP0942001
GP0942002



**PANNELLO IN LEGNO
CON GUIDE PER TASCHE***
wooden wall panel with slots*

45xh156 cm
80xh156 cm
120xh156 cm

GP0942400
GP0942401
GP0942402

***TASCA non incluse**
pocket not included

GC0001426



PANNELLO IN LEGNO BASSO
wooden wall panel – low

45xh38 cm
80xh38 cm
100xh38 cm
120xh38 cm

GP0943000
GP0943001
GP0943004
GP0943002



**PANNELLO IN LAMINATO BIANCO
BASSO**
white HPL wall panel – low

45xh38 cm
80xh38 cm
120xh38 cm

GP0943200
GP0943201
GP0943202



MENSOLA
shelf

45x25xh15 cm
80x25xh15 cm
120x25xh15 cm

GP0944000
GP0944001
GP0944002



SCRITTOIO
writing top

45x43xh25 cm
80x43xh25 cm
120x43xh25 cm

GP0944003
GP0944004
GP0944006



CONTENITORE A CASELLE
compartment top

45x45xh38 cm
80x45xh38 cm
120x45xh38 cm

GP0944020
GP0944021
GP0944022



**SCATOLA PER PANNELLO
IN LEGNO FORATO**
box for wooden panel with holes

39x26xh26 cm

GP0944023



SCATOLA
BOX

**Semplice contenitore rettangolare aperto.
Da utilizzare in orizzontale o in verticale.**

Rectangular open box.
To be used horizontally or vertically.

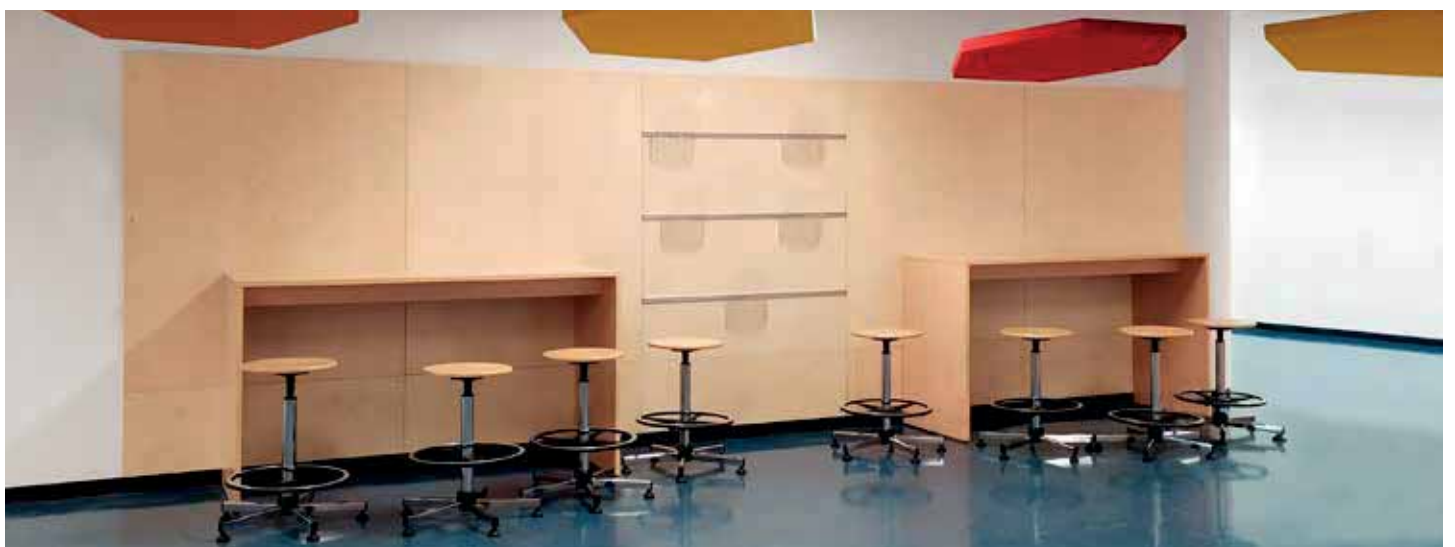

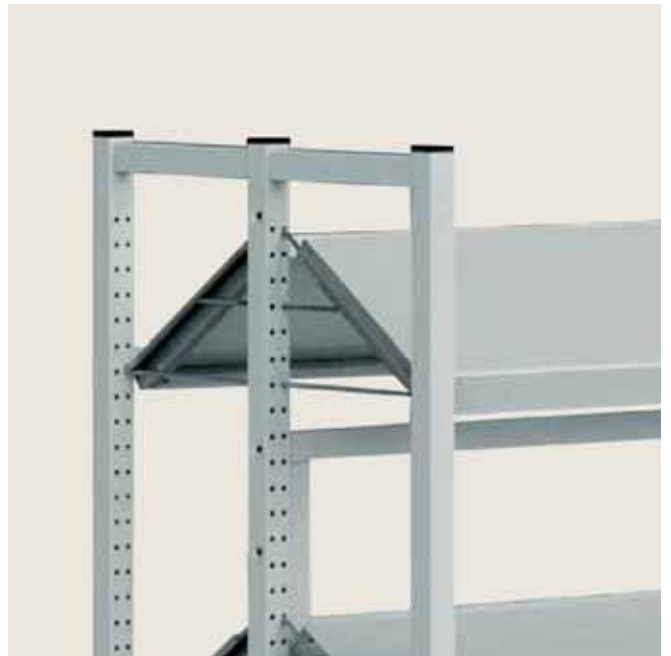



ABACHI SCAFFALI, CARTELLE COLORI

SHELVES CODIFICATION, COLOR CHARTS

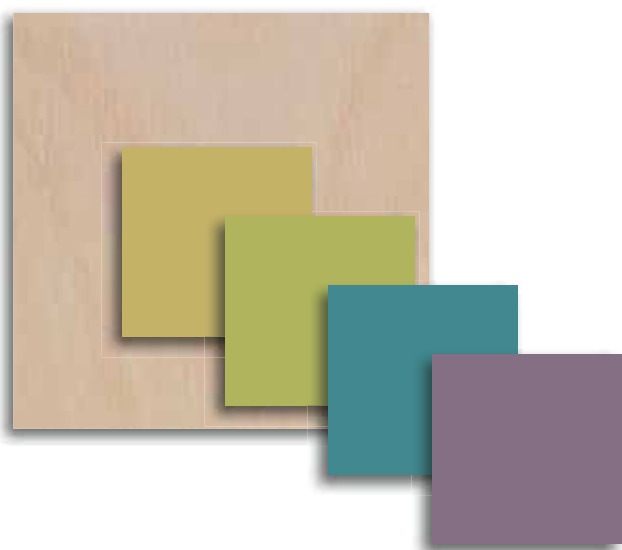

ABACHI SCAFFALI,
CARTELLE
COLORI

SHELVES CODIFICATION,
COLOR CHARTS

ABACO SISTEMA MODULAR

MODULAR SHELVING SYSTEM – ITEM CODES

MODULAR MONOFRONTA BASE | MODULAR SINGLE-SIDED STARTER BAY

L/W 53 cm

L/W 78 cm

L/W 93 cm

L/W 103 cm

MODULAR BASE 2 RIPIANI + TOP

MODULAR starter bay
2 shelves + top
H 79 cm



p/d 28 cm
p/d 33 cm

MB25050079
MB30050079

MB25075079
MB30075079

MB25090079
MB30090079

MB25100079
MB30100079

MODULAR BASE 3 RIPIANI + TOP

MODULAR starter bay
3 shelves + top
H 110 cm



p/d 28 cm
p/d 33 cm

MB25050110
MB30050110

MB25075110
MB30075110

MB25090110
MB30090110

MB25100110
MB30100110

MODULAR BASE 4 RIPIANI + TOP

MODULAR starter bay
4 shelves + top
H 150 cm



p/d 28 cm
p/d 33 cm

MB25050150
MB30050150

MB25075150
MB30075150

MB25090150
MB30090150

MB25100150
MB30100150

MODULAR BASE 5 RIPIANI + TOP

MODULAR starter bay
5 shelves + top
H 175 cm



p/d 28 cm
p/d 33 cm

MB25050175
MB30050175

MB25075175
MB30075175

MB25090175
MB30090175

MB25100175
MB30100175

MODULAR BASE 6 RIPIANI + TOP

MODULAR starter bay
6 shelves + top
H 205 cm



p/d 28 cm
p/d 33 cm

MB25050205
MB30050205

MB25075205
MB30075205

MB25090205
MB30090205

MB25100205
MB30100205

MODULAR BASE 6 RIPIANI + TOP

MODULAR starter bay
6 shelves + top
H 225 cm



p/d 28 cm
p/d 33 cm

MB25050225
MB30050225

MB25075225
MB30075225

MB25090225
MB30090225

MB25100225
MB30100225

MODULAR BASE 7 RIPIANI + TOP

MODULAR starter bay
7 shelves + top
H 257 cm



p/d 28 cm
p/d 33 cm

MB25050257
MB30050257

MB25075257
MB30075257

MB25090257
MB30090257

MB25100257
MB30100257

MODULAR MONOFRONTTE COMPONIBILE | MODULAR SINGLE-SIDED ADD-ON BAY

L/W 50 cm
L/W 75 cm
L/W 90 cm
L/W 100 cm
**MODULAR COMPONIBILE
2 RIPIANI + TOP**

 MODULAR add-on bay
2 shelves + top
H 79 cm

 p/d 28 cm
p/d 33 cm

MC25050079
MC30050079
MC25075079
MC30075079
MC25090079
MC30090079
MC25100079
MC30100079
**MODULAR COMPONIBILE
3 RIPIANI + TOP**

 MODULAR add-on bay
3 shelves + top
H 110 cm

 p/d 28 cm
p/d 33 cm

MC25050110
MC30050110
MC25075110
MC30075110
MC25090110
MC30090110
MC25100110
MC30100110
**MODULAR COMPONIBILE
4 RIPIANI + TOP**

 MODULAR add-on bay
4 shelves + top
H 150 cm

 p/d 28 cm
p/d 33 cm

MC25050150
MC30050150
MC25075150
MC30075150
MC25090150
MC30090150
MC25100150
MC30100150
**MODULAR COMPONIBILE
5 RIPIANI + TOP**

 MODULAR add-on bay
5 shelves + top
H 175 cm

 p/d 28 cm
p/d 33 cm

MC25050175
MC30050175
MC25075175
MC30075175
MC25090175
MC30090175
MC25100175
MC30100175
**MODULAR COMPONIBILE
6 RIPIANI + TOP**

 MODULAR add-on bay
6 shelves + top
H 205 cm

 p/d 28 cm
p/d 33 cm

MC25050205
MC30050205
MC25075205
MC30075205
MC25090205
MC30090205
MC25100205
MC30100205
**MODULAR COMPONIBILE
6 RIPIANI + TOP**

 MODULAR add-on bay
6 shelves + top
H 225 cm

 p/d 28 cm
p/d 33 cm

MC25050225
MC30050225
MC25075225
MC30075225
MC25090225
MC30090225
MC25100225
MC30100225
**MODULAR COMPONIBILE
7 RIPIANI + TOP**

 MODULAR add-on bay
7 shelves + top
H 257 cm

 p/d 28 cm
p/d 33 cm

MC25050257
MC30050257
MC25075257
MC30075257
MC25090257
MC30090257
MC25100257
MC30100257

ABACHI SCAFFALI, CARTELLE COLORI

SHELVES CODIFICATION,
COLOR CHARTS

MODULAR BIFRONTI BASE | MODULAR DOUBLE-SIDED STARTER BAY

L/W 53 cm

L/W 78 cm

L/W 93 cm

L/W 103 cm

MODULAR BASE 3+3 RIPIANI + TOP

MODULAR starter bay
3+3 shelves + top
H 110 cm



p/d 53 cm
p/d 63 cm

MB50050110
MB60050110

MB50075110
MB60075110

MB50090110
MB60090110

MB50100110
MB60100110

MODULAR BASE 4+4 RIPIANI + TOP

MODULAR starter bay
4+4 shelves + top
H 150 cm



p/d 53 cm
p/d 63 cm

MB50050150
MB60050150

MB50075150
MB60075150

MB50090150
MB60090150

MB50100150
MB60100150

MODULAR BASE 5+5 RIPIANI + TOP

MODULAR starter bay
5+5 shelves + top
H 175 cm



p/d 53 cm
p/d 63 cm

MB50050175
MB60050175

MB50075175
MB60075175

MB50090175
MB60090175

MB50100175
MB60100175

MODULAR BASE 6+6 RIPIANI + TOP

MODULAR starter bay
6+6 shelves + top
H 205 cm



p/d 53 cm
p/d 63 cm

MB50050205
MB60050205

MB50075205
MB60075205

MB50090205
MB60090205

MB50100205
MB60100205

MODULAR BASE 6+6 RIPIANI + TOP

MODULAR starter bay
6+6 shelves + top
H 225 cm



p/d 53 cm
p/d 63 cm

MB50050225
MB60050225

MB50075225
MB60075225

MB50090225
MB60090225

MB50100225
MB60100225

MODULAR BASE 7+7 RIPIANI + TOP

MODULAR starter bay
7+7 shelves + top
H 257 cm



p/d 53 cm
p/d 63 cm

MB50050257
MB60050257

MB50075257
MB60075257

MB50090257
MB60090257

MB50100257
MB60100257

MODULAR BIFRONTE COMPONIBILE | MODULAR DOUBLE-SIDED ADD-ON BAY

L/W 50 cm

L/W 75 cm

L/W 90 cm

L/W 100 cm

**MODULAR COMPONIBILE
3+3 RIPIANI + TOP**
MODULAR add-on bay
3+3 shelves + top
H 110 cm



p/d 53 cm
p/d 63 cm

MC50050110
MC60050110

MC50075110
MC60075110

MC50090110
MC60090110

MC50100110
MC60100110

**MODULAR COMPONIBILE
4+4 RIPIANI + TOP**
MODULAR add-on bay
4+4 shelves + top
H 150 cm



p/d 53 cm
p/d 63 cm

MC50050150
MC60050150

MC50075150
MC60075150

MC50090150
MC60090150

MC50100150
MC60100150

**MODULAR COMPONIBILE
5+5 RIPIANI + TOP**
MODULAR add-on bay
5+3 shelves + top
H 175 cm



p/d 53 cm
p/d 63 cm

MC50050175
MC60050175

MC50075175
MC60075175

MC50090175
MC60090175

MC50100175
MC60100175

**MODULAR COMPONIBILE
6+6 RIPIANI + TOP**
MODULAR add-on bay
6+6 shelves + top
H 205 cm



p/d 53 cm
p/d 63 cm

MC50050205
MC60050205

MC50075205
MC60075205

MC50090205
MC60090205

MC50100205
MC60100205

**MODULAR COMPONIBILE
6+6 RIPIANI + TOP**
MODULAR add-on bay
6+6 shelves + top
H 225 cm



p/d 53 cm
p/d 63 cm

MC50050225
MC60050225

MC50075225
MC60075225

MC50090225
MC60090225

MC50100225
MC60100225

**MODULAR COMPONIBILE
7+7 RIPIANI + TOP**
MODULAR add-on bay
7+7 shelves + top
H 257 cm



p/d 53 cm
p/d 63 cm

MC50050257
MC60050257

MC50075257
MC60075257

MC50090257
MC60090257

MC50100257
MC60100257

ABACHI SCAFFALI, CARTELLE COLORI

SHELVES CODIFICATION,
COLOR CHARTS

RIPIANI IN METALLO | METAL SHELVES

RIPIANO CON KIT ACCESSORI*

shelf with accessory kit*



l/w 50 cm
l/w 75 cm
l/w 90 cm
l/w 100 cm

P/D 25 cm

GB0RAA001
GB0RBA001
GB0RCA001
GB0RDA001

P/D 30 cm

GB0RAB001
GB0RBB001
GB0RCB001
GB0RDB001

RIPIANO CON BORDO FERMALIBRO E KIT ACCESSORI*

shelf with front book stop
and accessory kit*



l/w 50 cm
l/w 75 cm
l/w 90 cm
l/w 100 cm

GB0RAA002
GB0RBA002
GB0RCA002
GB0RDA002

GB0RAB002
GB0RBB002
GB0RCB002
GB0RDB002

RIPIANO INCLINATO CON BORDO FERMALIBRO E KIT ACCESSORI**

inclined shelf with front book
stop and accessory kit**



l/w 50 cm
l/w 75 cm
l/w 90 cm
l/w 100 cm

GB0RAA003
GB0RBA003
GB0RCA003
GB0RDA003

GB0RAB003
GB0RBB003
GB0RCB003
GB0RDB003

* **KIT ACCESSORI** composto da n.4 aste di supporto **GAM 1**

ACCESSORY KIT includes n.4 support rods **GAM 1**

** **KIT ACCESSORI** composto da n.2 aste **GAM1** e n.2 ganci per inclinazione **GAM 2**

ACCESSORY KIT includes n.2 support rods **GAM 1** and n.2 hooks for shelf inclination **GAM 2**

PANNELLI LATERALI | END PANELS

PANNELLO LATERALE IN LEGNO

wooden end panel

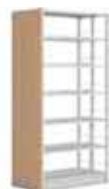

h 79 cm
h 110 cm
h 150 cm
h 175 cm
h 205 cm
h 225 cm
h 257 cm

P/D 28 cm

GBZP001SS
GB1P0AA03
GB1P0AB03
GB1P0AC03
GB1P0AD03
GB1P0AE03
GB1P0AF03

P/D 33 cm

GB1P047SS
GB1P0BA03
GB1P0BB03
GB1P0BC03
GB1P0BD03
GB1P0BE03
GB1P0BF03

P/D 53 cm

GB1P0AA04
GB1P0AB04
GB1P0AC04
GB1P0AD04
GB1P0AE04
GB1P0AF04

P/D 63 cm

GB1P0BA04
GB1P0BB04
GB1P0BC04
GB1P0BD04
GB1P0BE04
GB1P0BF04

PANNELLO LATERALE IN LAMIERA FORATA FORI QUADRI

perforated metal end panel
(square holes)



h 79 cm
h 110 cm
h 150 cm
h 175 cm
h 205 cm
h 225 cm
h 257 cm

GB1P037SS
GB1P0AA06
GB1P0AB06
GB1P0AC06
GB1P0AD06
GB1P0AE06
GB1P0AF06

GB1P053SS
GB1P0BA06
GB1P0BB06
GB1P0BC06
GB1P0BD06
GB1P0BE06
GB1P0BF06

KIT FERRAMENTA PER PANNELLO LATERALE IN LEGNO

hardware fixing kit
for wooden end panel

<h 200 cm
>h 200 cm

GB1K00003
GB1K00005

TOP SCAFFALE | TOP PANELS

TOP IN LEGNO

wooden tops



ml

P/D 28 cm

GB1P0A037

P/D 33 cm

GB1P0B037

P/D 53 cm

GB1P0C037

P/D 63 cm

GB1P0D037

KIT FERRAMENTA PER TOP

hardware fixing kit
for top panel

n.1 per ogni scaffale monofronte | for each single-sided bay
n.2 per ogni scaffale bifronte | for each double-sided bay

GB1K00004

FIANCHI SPECIALI | SPECIAL END PANELS

P/D 53 cm

P/D 63 cm

**FIANCHI SPECIALI
PIANO CONSULTAZIONE**

special end panels
consultation desk



70xh100/205 cm **GB1P052SS**
70xh100/225 cm **GB1P041SS**

GB1P054SS
GB1P055SS

**FIANCHI SPECIALI
SEDUTA INFORMALE
MORBIDA**

special end panels
informal padded bench



50xh44 cm **GC0002300**
63xh44 cm
96,5xh44 cm **GC0005213**

GC0003050
GC0005691

ANTE | DOORS

MODULAR BASE
MODULAR STARTER BAY

MODULAR COMPONIBILE
MODULAR ADD-ON BAY

L/W 90 cm

L/W 100 cm

L/W 90 cm

L/W 100 cm

ANTE IN LEGNO
wooden doors



h 110 cm
h 150 cm
h 175 cm
h 205 cm
h 225 cm

GB1AC0A01
GB1AC0B01
GB1AC0C01
GB1AC0D01
GB1AC0E01

GB1AD0A01
GB1AD0B01
GB1AD0C01
GB1AD0D01
GB1AD0E01

GB1AC0A02
GB1AC0B02
GB1AC0C02
GB1AC0D02
GB1AC0E02

GB1AD0A02
GB1AD0B02
GB1AD0C02
GB1AD0D02
GB1AD0E02

**ANTE IN VETRO
CON CORNICE LEGNO**
glass doors with wooden frame



h 110 cm
h 150 cm
h 175 cm
h 205 cm
h 225 cm

GB1AC0A03
GB1AC0B03
GB1AC0C03
GB1AC0D03
GB1AC0E03

GB1AD0A03
GB1AD0B03
GB1AD0C03
GB1AD0D03
GB1AD0E03

GB1AC0A04
GB1AC0B04
GB1AC0C04
GB1AC0D04
GB1AC0E04

GB1AD0A04
GB1AD0B04
GB1AD0C04
GB1AD0D04
GB1AD0E04

ANTE IN VETRO
glass doors



h110 cm
h150 cm
h175 cm
h205 cm
h225 cm

GB1AC0A05
GB1AC0B05
GB1AC0C05
GB1AC0D05
GB1AC0E05

GB1AD0A05
GB1AD0B05
GB1AD0C05
GB1AD0D05
GB1AD0E05

GB1AC0A06
GB1AC0B06
GB1AC0C06
GB1AC0D06
GB1AC0E06

GB1AD0A06
GB1AD0B06
GB1AD0C06
GB1AD0D06
GB1AD0E06

ABACHI SCAFFALI, CARTELLE COLORI

SHELVES CODIFICATION,
COLOR CHARTS

ACCESSORI CONSULTAZIONE | CONSULTATION ACCESSORIES



**RIPIANO RIBALTABILE IN METALLO
PER FIANCATA BIFRONTE**
folding metal shelf for double-sided bay

53 cm **GB0R0A008**
63 cm **GB0R0B008**



**RIPIANO RIBALTABILE IN LEGNO
PER FIANCATA BIFRONTE**
folding wooden shelf for double-sided bay

53 cm **GB0R0A029**
63 cm **GB0R0B029**



**RIPIANO IN LEGNO
PER FIANCATA BIFRONTE**
wooden shelf for double-sided bay

53 cm **GB0R0A027**
63 cm **GB0R0B027**



**RIPIANO RIBALTABILE IN LEGNO
PER FIANCATA BIFRONTE
CON PANNELLO LATERALE IN LEGNO**
folding wooden shelf for double-sided bay
with wooden end panel

53 cm **GB0R0A030**
63 cm **GB0R0B030**



**RIPIANO IN LEGNO PER FIANCATA
BIFRONTE CON PANNELLO LATERALE
IN LEGNO**
wooden shelf for double-sided bay
with wooden end panel

53 cm **GB0R0A026**
63 cm **GB0R0B026**



**RIPIANO TRIANGOLARE
IN LEGNO DI COLLEGAMENTO
CON KIT ACCESSORI***
wooden triangular shelf with accessory kit*

90° monofronte | single-sided **GB0RXA021**
90° bifronte | double-sided **GB0RXA020**



**RIPIANO SEMICIRCOLARE
IN LEGNO DI COLLEGAMENTO
CON KIT ACCESSORI***
wooden semicircular shelf with accessory kit*

90° monofronte | single-sided **GB0RXA023**
90° bifronte | double-sided **GB0RXA022**

*KIT ACCESSORI composto da n.4 aste di supporto GAM 1
ACCESSORY KIT includes n.4 support rods GAM 1

ZOCCOLI E RUOTE | KICK PLATES AND CASTORS



ZOCCOLO FRONTALE
front kick plate

50 cm **GB1ZA0006**
75 cm **GB1ZB0006**
90 cm **GB1ZC0006**
100 cm **GB1ZD0006**



ZOCCOLO TRASVERSALE
side kick plate

25 cm **GB1ZA0004**
30 cm **GB1ZB0004**
50 cm **GB1ZA0005**
60 cm **GB1ZB0005**



**KIT RUOTE SENZA FRENO
PER MONTANTE BIFRONTE**
set of castors with support
for double-sided bay

53 cm **GB3Z00011**
63 cm **GB3Z00013**



**KIT RUOTE CON FRENO
PER MONTANTE BIFRONTE**
set of castors with support
and brake for double-sided bay

53 cm **GB3Z00012**
63 cm **GB3Z00014**

MODULAR CURVO BIFRONTE | MODULAR CURVED DOUBLE-SIDED BAY

P/D 53 cm

**MODULAR BASE
3+3 RIPIANI + TOP**

MODULAR starter bay
3+3 shelves + top

H 110 cm



R 100/153 cm **GB1M081SS**

**MODULAR BASE
4+4 RIPIANI + TOP**

MODULAR starter bay
4+4 shelves + top

H 150 cm



R 100/153 cm **GB1M083SS**

**MODULAR COMPONIBILE
3+3 RIPIANI + TOP**

MODULAR add-on bay
3+3 shelves + top

H 110 cm



R 100/153 cm **GB1M082SS**

**MODULAR COMPONIBILE
4+4 RIPIANI + TOP**

MODULAR add-on bay
4+4 shelves + top

H 150 cm



R 100/153 cm **GB1M084SS**

**KIT RUOTE
PER SCAFFALE CURVO ***

set of castors for curved bay *

GB3Z015SS

*** KIT PER SCAFFALE
BASE CON 4 RUOTE**

set of 4 castors for curved starter bay

CODIFICA MODULAR

MODULAR CODIFICATION

Ogni scaffale MODULAR è identificato da un codice basato sulla tipologia e sulle dimensioni dello scaffale.

Each MODULAR bay is identified by a code based on the type and dimensions of the shelf.

TIPOLOGIA | TYPE :

B = MODULAR BASE | MODULAR starter bay

C = MODULAR COMPONIBILE | MODULAR add-on bay

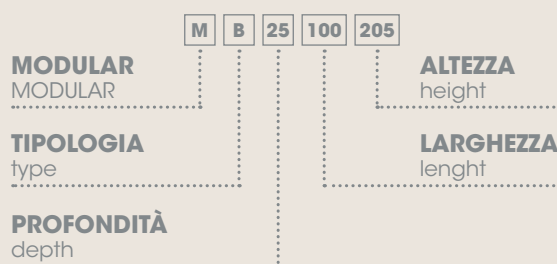

ABACHI SCAFFALI,
CARTELLE
COLORI

SHELVES CODIFICATION,
COLOR CHARTS

ABACO SISTEMA EPIFANO

EPIFANO SHELVING SYSTEM – ITEM CODES

EPIFANO MONOFRONTA BASE | EPIFANO SINGLE-SIDED STARTER BAY

L/W 74 cm

L/W 92 cm

**EPIFANO BASE
3 RIPIANI + TOP**

EPIFANO starter bay
3 shelves + top

H 90 cm



p/d 34 cm

GB5M10276

GB5M10013

**EPIFANO BASE
3 RIPIANI + TOP**

EPIFANO starter bay
3 shelves + top

H 120 cm



p/d 34 cm

GB5MBAI21

GB5MCAI21

**EPIFANO BASE
4 RIPIANI + TOP**

EPIFANO starter bay
4 shelves + top

H 150 cm



p/d 34 cm

GB5M10257

GB5M10012

**EPIFANO BASE
4 RIPIANI + TOP**

EPIFANO starter bay
4 shelves + top

H 180 cm



p/d 34 cm

GB5MBAG21

GB5MCAG21

**EPIFANO BASE
5 RIPIANI + TOP**

EPIFANO starter bay
5 shelves + top

H 210 cm



p/d 34 cm

GB5MBAP21

GB5MCAP21

EPIFANO BIFRONTA BASE | EPIFANO DOUBLE-SIDED STARTER BAY

L/W 74 cm

L/W 92 cm

**EPIFANO BASE
3+3 RIPIANI + TOP**

EPIFANO starter bay
3+3 shelves + top

H 120 cm



p/d 63 cm

GB5M10106

GB5MCAI23

**EPIFANO BASE
4+4 RIPIANI + TOP**

EPIFANO starter bay
4+4 shelves + top

H 150 cm



p/d 63 cm

GB5M10102

GB5M10236

**EPIFANO BASE
4+4 RIPIANI + TOP**

EPIFANO starter bay
4+4 shelves + top

H 180 cm



p/d 63 cm

GB5MBAG23

GB5MCAG23

**EPIFANO BASE
5+5 RIPIANI + TOP**

EPIFANO starter bay
5+5 shelves + top

H 210 cm



p/d 63 cm

GB5M10082

GB5MCAP23

EPIFANO MONOFRONTE COMPONIBILE | EPIFANO SINGLE-SIDED ADD-ON BAY

L/W 71,5 cm

L/W 89,5 cm

**EPIFANO COMPONIBILE
3 RIPIANI + TOP**

EPIFANO add-on bay
3 shelves + top

H 90 cm



p/d 34 cm

GB5M10250

GB5M10247

**EPIFANO COMPONIBILE
3 RIPIANI + TOP**

EPIFANO add-on bay
3 shelves + top

H 120 cm



p/d 34 cm

GB5MBAI22

GB5MCAI22

**EPIFANO BASE
4 RIPIANI + TOP**

EPIFANO add-on bay
4 shelves + top

H 150 cm



p/d 34 cm

GB5M10258

GB5M10237

**EPIFANO COMPONIBILE
4 RIPIANI + TOP**

EPIFANO add-on bay
4 shelves + top

H 180 cm



p/d 34 cm

GB5M10070

GB5MCAG22

**EPIFANO COMPONIBILE
5 RIPIANI + TOP**

EPIFANO add-on bay
5 shelves + top

H 210 cm



p/d 34 cm

GB5MBAP22

GB5MCAP22

EPIFANO BIFRONTE COMPONIBILE | EPIFANO DOUBLE-SIDED ADD-ON BAY

L/W 71,5 cm

L/W 89,5 cm

**EPIFANO COMPONIBILE
3+3 RIPIANI + TOP**

EPIFANO add-on bay
3+3 shelves + top

H 120 cm



p/d 63 cm

GB5M10107

GB5MCAI24

**EPIFANO COMPONIBILE
4+4 RIPIANI + TOP**

EPIFANO add-on bay
4+4 shelves + top

H 150 cm



p/d 63 cm

GB5M10274

GB5M10022

**EPIFANO COMPONIBILE
4+4 RIPIANI + TOP**

EPIFANO add-on bay
4+4 shelves + top

H 180 cm



p/d 63 cm

GB5M10100

GB5MCAG24

**EPIFANO COMPONIBILE
5+5 RIPIANI + TOP**

EPIFANO add-on bay
5+5 shelves + top

H 210 cm



p/d 63 cm

GB5M10084

GB5MCAP24

ABACHI SCAFFALI, CARTELLE COLORI

SHELVES CODIFICATION,
COLOR CHARTS

RIPIANO IN METALLO | METAL SHELF

P/D 26 cm

RIPIANO CON BORDO FERMALIBRO E KIT*

shelf with front book stop
and accessory kit*



l/w 70 cm
l/w 90 cm

GB5M10075
GB5RCA002

* **KIT composto da n.4 reggipiani in zama**
ACCESSORY KIT includes n.4 shelf supports

ANTE | DOORS

L/W 92 cm

ANTE IN LEGNO wooden doors



h 88 cm
h 204 cm

GB5M10034
GB5M10131

ANTE IN CRISTALLO plate glass doors



h 88 cm
h 204 cm

GB5M10035
GB5M10037

FIANCO ESPOSITORE | SIDE DISPLAY

P/D 63 cm

FIANCO ESPOSITORE side display



h 120 cm
h 150 cm
h 180 cm
h 210 cm

GB5M10239
GB5M10240
GB5M10241
GB5M10242

ZOCCOLO E RUOTE | KICK PLATE AND CASTORS



ZOCCOLO FRONTALE front kick plate

69 cm
87 cm

GB5M10040
GB5M10039



SISTEMA CARRELLATO* castor set*

63 cm

GB5M10264

* **disponibile solo per scaffali bifronti**
L 92 cm
available for double-sided bays cm W92 only

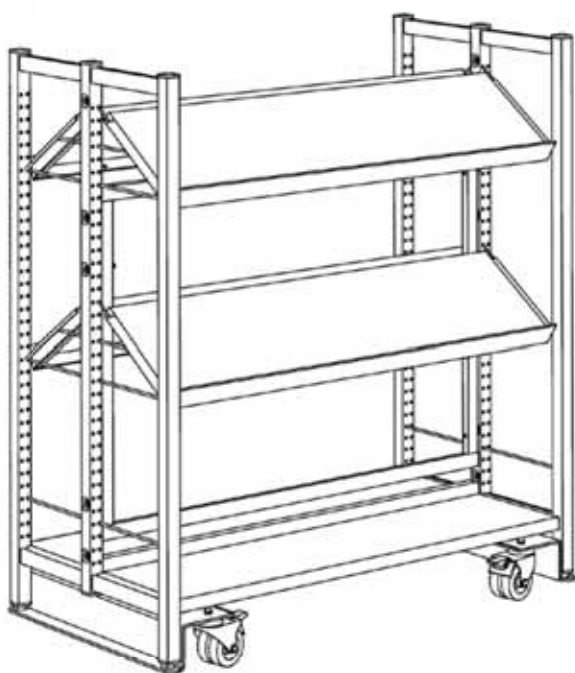

CERTIFICAZIONI

CERTIFICATIONS

EN 16121-2013 + A1-2017

Mobili contenitori non domestici – Requisiti per la sicurezza, la resistenza, la durabilità e la stabilità

Non-domestic storage furniture – Requirements for safety, strength, durability and stability

EN 16122-2012 + AC-2015

Mobili contenitori domestici e non domestici – Metodi di prova per la determinazione di resistenza, durabilità e stabilità

Domestic and non-domestic storage furniture – Test methods for the determination of strength, durability and stability

ABACHI SCAFFALI, CARTELLE COLORI

SHELVES CODIFICATION,
COLOR CHARTS

CARTELLE COLORI COLOR CHARTS

BANCO ACCOGLIENZA | RECEPTION DESK

struttura
structure



accessori
accessories



LOCKERS, SISTEMA 618 – CONTENITORI E ACCESSORI | LOCKERS, SYSTEM 618 – CABINETS AND ACCESSORIES

cassa
structure



struttura metallica
metal base



ante, accessori
doors, accessories



nicchie, microspazio
niches, microspace



PUNTO E VIRGOLA
PUNTO E VIRGOLA



ESPOSITORI METALLICI, GAM BOX | METAL DISPLAYS, GAM BOX

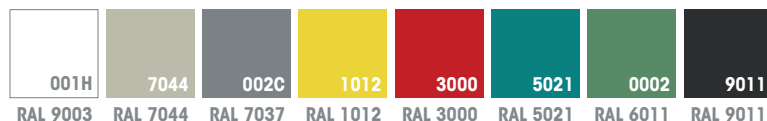

CARRELLO PORTALIBRI A 4 RIPIANI | BOOK TROLLEY WITH 4 INCLINED SHELVES

COMBINAZIONE 01
COMBINATION 01



COMBINAZIONE 02
COMBINATION 02



COMBINAZIONE 03
COMBINATION 03



CARRELLO PORTALIBRI A 3 RIPIANI | BOOK TROLLEY WITH 3 INCLINED METAL SHELVES

fianchi
sides



ripiani
shelves

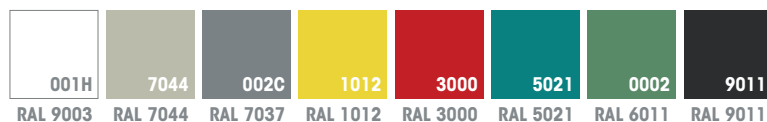

BOX RESTITUZIONE LIBRI DA INTERNO | INDOOR BOOK RETURN BOX



BOX RESTITUZIONE LIBRI DA ESTERNO | OUTDOOR BOOK RETURN BOX



SISTEMA PANCHE ELLE, BUKSOFA | ELLE BENCHES, BUKSOFA

sistema panche ELLE
ELLE benches



BUKSOFA
BUKSOFA



ABACHI SCAFFALI, CARTELLE COLORI

SHELVES CODIFICATION,
COLOR CHARTS

SISTEMA MODULAR | MODULAR SHELVING SYSTEM

pannelli laterali, accessori SPECIAL

end panels, SPECIAL accessories



scaffale MODULAR, ripiani, pannelli laterali in metallo forato, accessori metallici

MODULAR metal shelves, perforated metal end panels, metal accessories

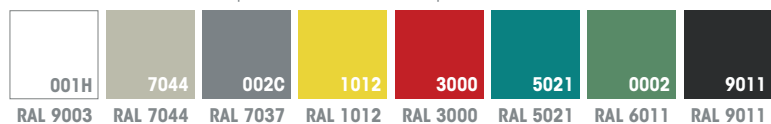

SISTEMA EPIFANO | EPIFANO SHELVING SYSTEM

fianchi

end panels



ripiani

shelves

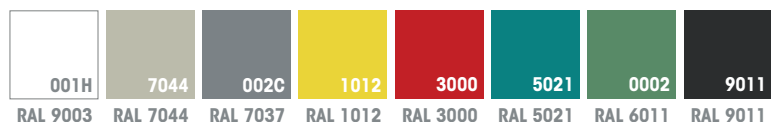

SISTEMA INSERT | INSERT SYSTEM

scaffale

shelf



accessori in nobilitato

MFC accessories



accessori in laccato e nobilitato

lacquered and MFC accessories



ESPOSITORI A SCHEDARIO, SU RUOTE, A SCALARE | BOOK BROWSERS



struttura metallica

metal frame

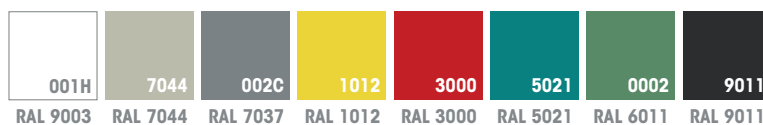

PANNELLI FONOASSORBENTI | SOUND-ABSORBING PANELS



PEDANE, GRADONI, PANCHE | PLATFORMS, TWO-TIERED SEATINGS, BENCHES

pedane
platforms



gradoni
two-tiered seatings



panche
benches



ESAGONI | HEXAGONS

struttura
structure



fondo
bottom



SISTEMA 06 – POUF, SISTEMA 618 – POUF, POUF, MORBIDI | SYSTEM 06 – POUFS, SYSTEM 618 – POUFS, POUFS, SOFT FURNISHINGS

morbidi
padding

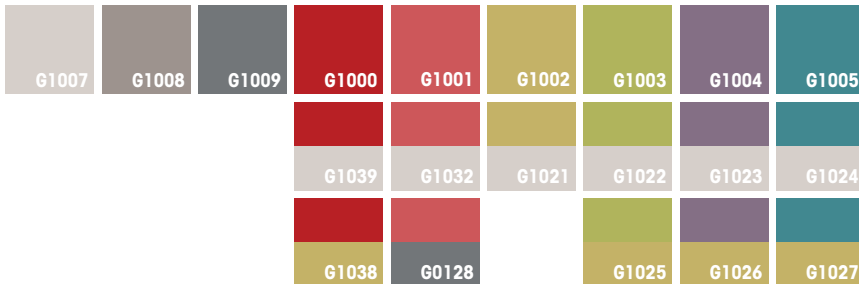

gambe SISTEMA 06 – pouf
SYSTEM 06 – POUF feet



struttura metallica SISTEMA 618 – pouf
SYSTEM 06 – POUF metal base

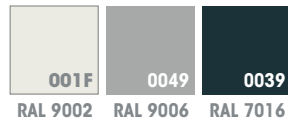

TAPPETI | CARPETS

treford
treford



moquette
moquette



ACCESSORI SISTEMA PARETE | ACCESSORIES FOR WALL SYSTEM



ABACHI SCAFFALI, CARTELLE COLORI

SHELVES CODIFICATION,
COLOR CHARTS

KALEOX | KALEOX



TAVOLINO KENSHO | KENSHO SMALL TABLE



IDEA+, POP-UP, TAVOLI RIUNIONE, TAVOLO TONDO CON GAMBONE | IDEA+, POP UP, MEETING ROOM TABLES, ROUND TABLE WITH CENTRAL LEG

piano in melaminico
MFC tabletop

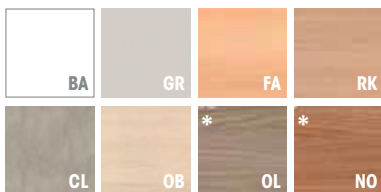

*finitura unica per tavolo riunione singolo
con struttura cubo
single finish for meeting table with cube structure

struttura metallica
metal frame



TAVOLI ALTO | HIGH TABLES

piano di lavoro
table top



*finitura su richiesta con variazione di prezzo
finish on demand at extra cost

struttura metallica
metal frame

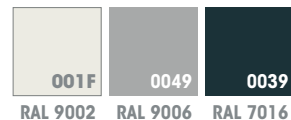

KAPIO | KAPIO



CONSOLE, PANNELLO DIVISORIO | CONSOLE, PARTITION PANEL

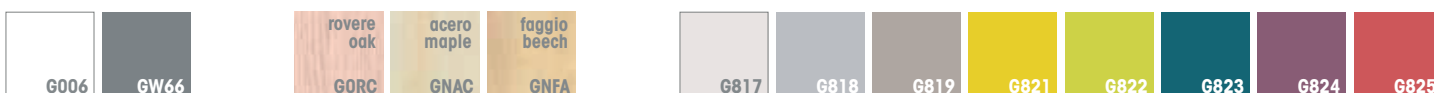

POSTAZIONI OPAC | OPAC WORKSTATION

piano di lavoro, fianchi table top, sides



struttura metallica metal frame

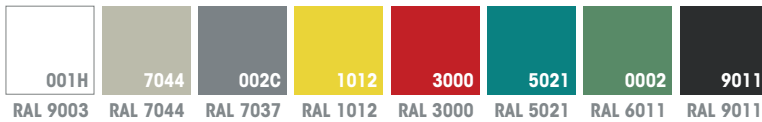

TAVOLI STUDIO | STUDY TABLES

piano di lavoro, fianchi table top, sides



contenitore soprapiano countertop unit

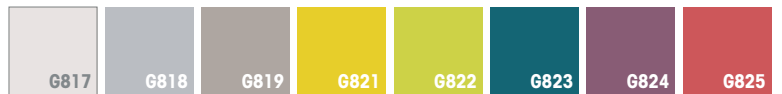

struttura metallica metal frame

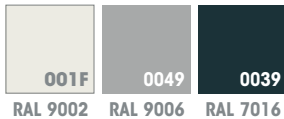

SISTEMA 618 – TAVOLI | SYSTEM 618 – TABLES

piano di lavoro table top



* finitura su richiesta con variazione di prezzo
finish on demand at extra cost

struttura metallica metal frame



SISTEMA 06 – TAVOLI | SYSTEM 06 – TABLES

piano di lavoro table top



gambe legs



TAVOLO GIAPPONESE | JAPANESE TABLE



ABACHI SCAFFALI, CARTELLE COLORI

SHELVES CODIFICATION,
COLOR CHARTS

KUBIX, KARMA, KORIUUM MESH | KUBIX, KARMA, KORIUUM MESH

ecopelle
eco-leather



tessuto
fabric



**schienale in rete colore nero
per KARMA e KORIUUM MESH**
black mesh backrest
for KARMA and KORIUUM MESH

KUARK | KUARK

scocca in polipropilene
polypropylene shell



cuscino
cushion



TONA, MIT | TONA, MIT

ecopelle CALLAO
eco-leather CALLAO



tessuto MORELIA
fabric MORELIA



tessuto MANAGUA
fabric MANAGUA

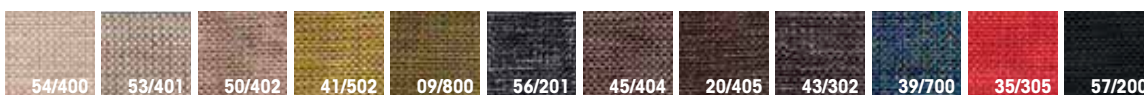

KENDO, KONTEX, KENSHO, KUAD | KENDO, KONTEX, KENSHO, KUAD

ecopelle
eco-leather



MANTRA | MANTRA

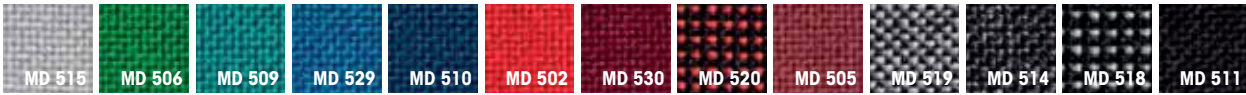

POINT, POINT Q | POINT, POINT Q

ecopelle
eco-leather

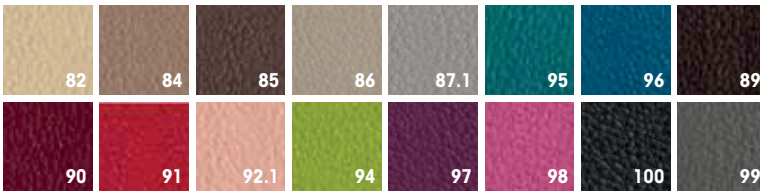

tessuto
fabric



TRIO | TRIO



ABACHI SCAFFALI, CARTELLE COLORI

SHELVES CODIFICATION,
COLOR CHARTS

KALEA | KALEA

scocca in polipropilene
polypropylene shell



**omologazione al fuoco classe 1
con sovrapprezzo per colore crema**
class 1 fire homologation
at extra cost for cream color

ecopelle
eco-leather



tessuto
fabric

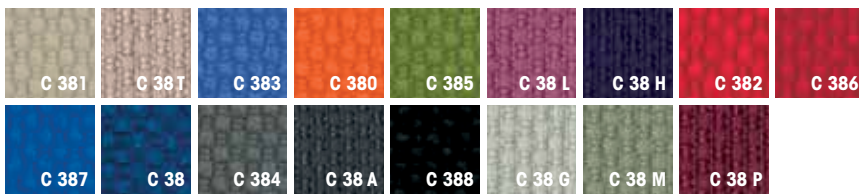

CLOP | CLOP

scocca in polipropilene
polypropylene shell



cuscino
cushion



KLIA | KLIA



**omologazione al fuoco classe 1
con sovrapprezzo per colore crema**
class 1 fire homologation
at extra cost for cream color

KICCA | KICCA

scocca in polipropilene polypropylene shell



**omologazione al fuoco classe 1
con sovrapprezzo per colore crema e grigio**
class 1 fire homologation
at extra cost for cream and grey color

KICCA PLUS | KICCA PLUS

ecopelle eco leather



G-TYPE | G-TYPE

scocca plastica plastic shell



*** disponibile anche nella versione con scocca in plastica riciclata
e con scocca ignifuga CL1**
also available with recycled plastic shell and with CL1 fireproof shell

scocca in legno wooden shell



**** faggio beech
GNFA**
** * finitura su richiesta con variazione di prezzo
finish on demand at extra cost

struttura metallica metal frame

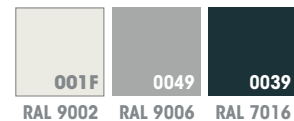

POSTURA | POSTURA



TURIN | TURIN

scocca in legno wooden shell



struttura metallica metal frame

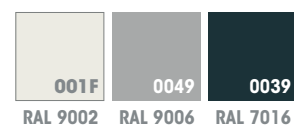





GAM BIBLIOTECHE

GAM LIBRARIES



GAM BIBLIOTECHE

GAM LIBRARIES





Biblioteca LAC Libri Arte e Cultura a Baselga di Piné, Trento

Library LAC Libri Arte e cultura in Baselga di Piné, Trento

immagini: Giovanni Marangon

GAM BIBLIOTECHE

GAM LIBRARIES





Biblioteca Carlo Mosso del conservatorio Antonio Vivaldi ad Alessandria

Carlo Mosso Library – Antonio Vivaldi conservatory in Alessandria

immagini: Giovanni Marangon

GAM BIBLIOTECHE

GAM LIBRARIES



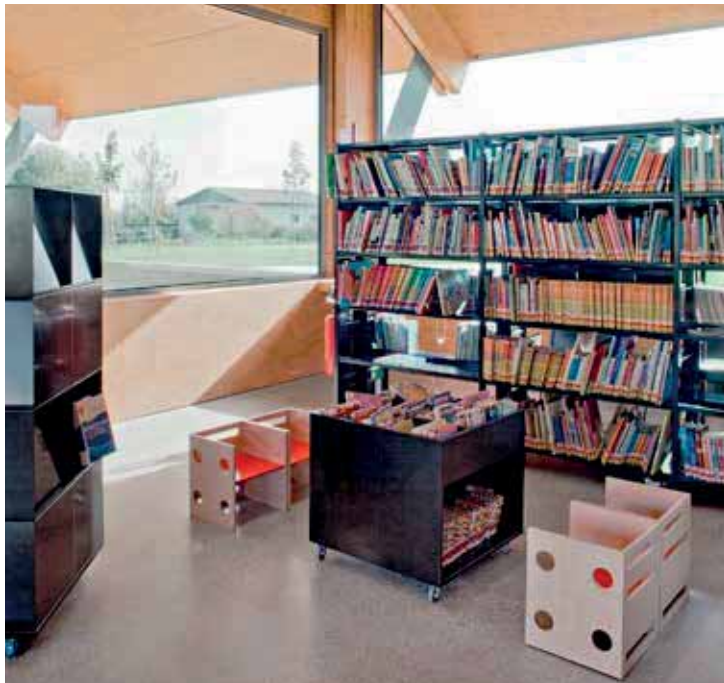

Biblioteca Biblioio a Veggiano, Padova

Biblioio Library in Veggiano, Padova

immagini: MIDEarchitetti

GAM BIBLIOTECHE

GAM LIBRARIES





Biblioteca Palazzo Baccin Bilbliomuseo a Nove, Vicenza

Bibliomuseo Palazzo Baccin Library in Nove, Vicenza

immagini: Claudio Battisti, Mariano Tafferini

GAM BIBLIOTECHE

GAM LIBRARIES





Biblioteca G. Gerosa Bricchetto a Peschiera Borromeo, Milano

G. Gerosa Bricchetto Library in Peschiera Borromeo, Milano

immagini: Claudio Battisti

GAM BIBLIOTECHE

GAM LIBRARIES





Mantua Farm School a Curtatone, Mantova

Mantua Farm School in Curtatone, Mantova

immagini: Claudio Battisti, Giovanni Marangon

GAM BIBLIOTECHE

GAM LIBRARIES





Biblioteca Civica Junior a Parma

Junior Civic Library in Parma

immagini: Claudio Battisti, Giovanni Marangon

GAM BIBLIOTECHE

GAM LIBRARIES





Biblioteca Sovracomunale a Pergine Valsugana e Valle del Fersina, Trento

Council Library in Pergine Valsugana e Valle del Fersina, Trento

immagini: Alterstudio Partners, Gianluca Perottoni Architetto

GAM BIBLIOTECHE

GAM LIBRARIES





Biblioteca P. M. Beghi a La Spezia

P. M. Beghi Library in La Spezia

immagini: Claudio Battisti, Gianluca Giubilei

GAM BIBLIOTECHE

GAM LIBRARIES





Biblioteca P. M. Beghi a La Spezia

P. M. Beghi Library in La Spezia

immagini: Claudio Battisti, Gianluca Giubilei

GAM BIBLIOTECHE

GAM LIBRARIES





Biblioteca Beato Pellegrino di Studi Letterari, Linguistici, Pedagogici e dello Spettacolo presso l'Università degli Studi di Padova, Padova

Beato Pellegrino University Library c/o Università degli Studi di Padova, Padova

immagini: Ruben Verdi Architetto

GAM BIBLIOTECHE

GAM LIBRARIES





Biblioteca Beato Pellegrino di Studi Letterari, Linguistici, Pedagogici e dello Spettacolo presso l'Università degli Studi di Padova, Padova

Beato Pellegrino University Library c/o Università degli Studi di Padova, Padova

immagini: Ruben Verdi Architetto

GAM BIBLIOTECHE

GAM LIBRARIES





Biblioteca A. Rosmini a Toscolano Maderno, Brescia

A. Rosmini Library in Toscolano Maderno, Brescia

immagini: Gianluca Giubilei

GAM BIBLIOTECHE

GAM LIBRARIES





Biblioteca Mario Luzi a San Miniato, Pisa

Mario Luzi Library in San Miniato, Pisa

immagini: Gianluca Giubilei

GAM BIBLIOTECHE

GAM LIBRARIES





Biblioteca Comunale Renato Fucini a Empoli, Firenze

Renato Fucini Council Library in Empoli, Firenze

immagini: Gianluca Giubilei

GAM BIBLIOTECHE

GAM LIBRARIES



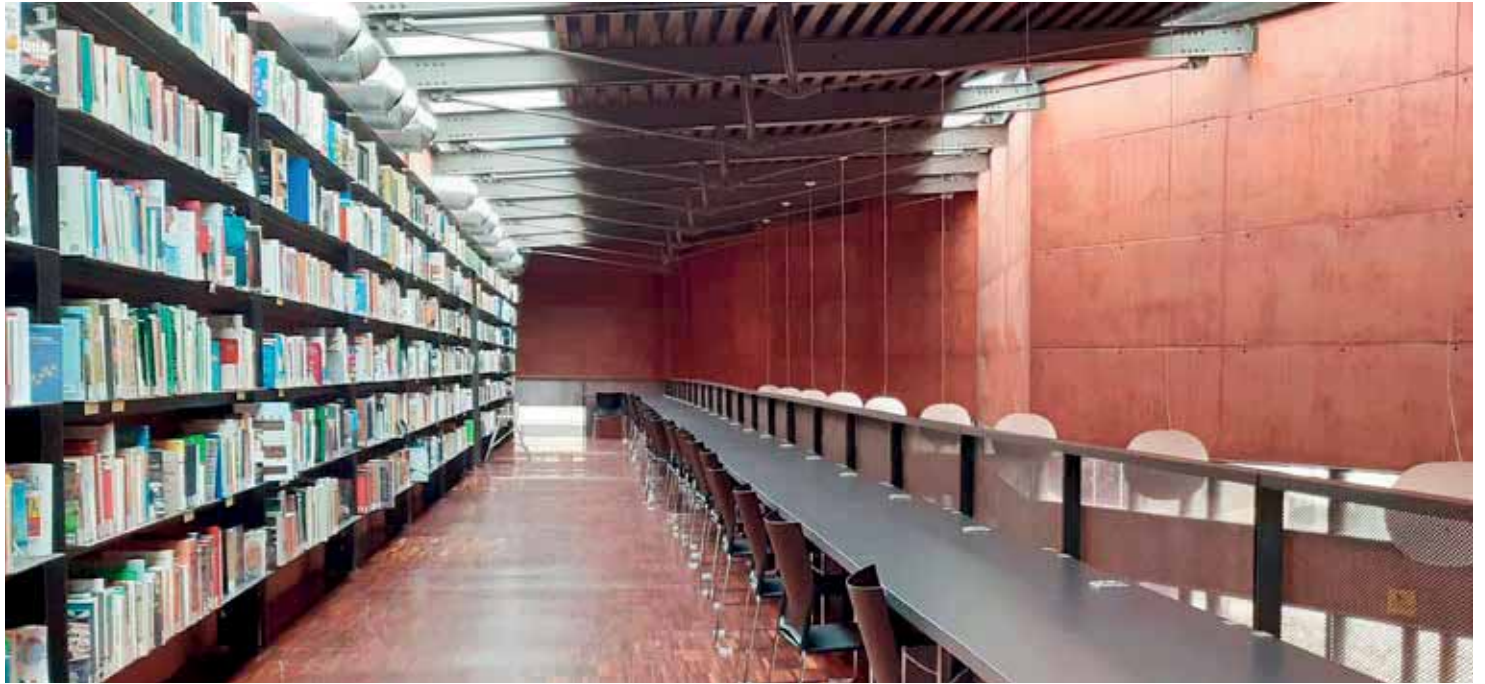

Biblioteca Rita Levi Montalcini a Curno, Bergamo

Rita Levi Montalcini Library in Curno, Bergamo

immagini: Claudio Battisti



GAM è anche SCUOLE
GAM also means SCHOOLS



GAM è anche NIDI E SCUOLE D'INFANZIA
GAM also means NURSERIES
AND KINDERGARTENS



GAM è anche MATERIALI MONTESSORI
GAM also means MONTESSORI
MATERIALS



DESIGN GAM
GAM DESIGN



CERTIFICAZIONI
CERTIFICATIONS



GAM

GAM

GAM è anche SCUOLE GAM also means SCHOOLS





GAM è protagonista del rinnovamento della scuola italiana. Progetta allestimenti e arredi che interpretano nuovi modi di apprendere e insegnare. GAM realizza scuole di qualità su scala internazionale.

GAM is the protagonist of the renewal of the Italian school. He designs installations and furnishings that interpret new ways of learning and teaching. GAM builds quality schools on an international scale.

GAM

GAM

GAM è anche NIDI E SCUOLE D'INFANZIA
GAM also means NURSERIES AND KINDERGARTENS

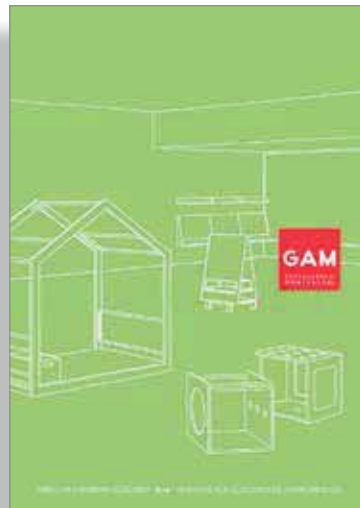

Photo Credits to DSL Studio - Delfino Sisto Legnani, Marco Cappelletti



GAM arreda spazi che accolgono i bambini e sostengono la loro crescita. Da decenni contribuisce alla costruzione di una moderna cultura dei servizi per l'infanzia.

GAM disegna e produce arredi e oggetti divenuti standard universalmente riconosciuti e molto imitati.

GAM furnishes environments that welcome children and support their growth. For decades it has contributed to the construction of a modern culture of childcare services.

GAM designs and produces furnishings that have become universally recognized and much imitated.

GAM

GAM

GAM è anche MATERIALE MONTESSORI
GAM also means MONTESSORI MATERIALS



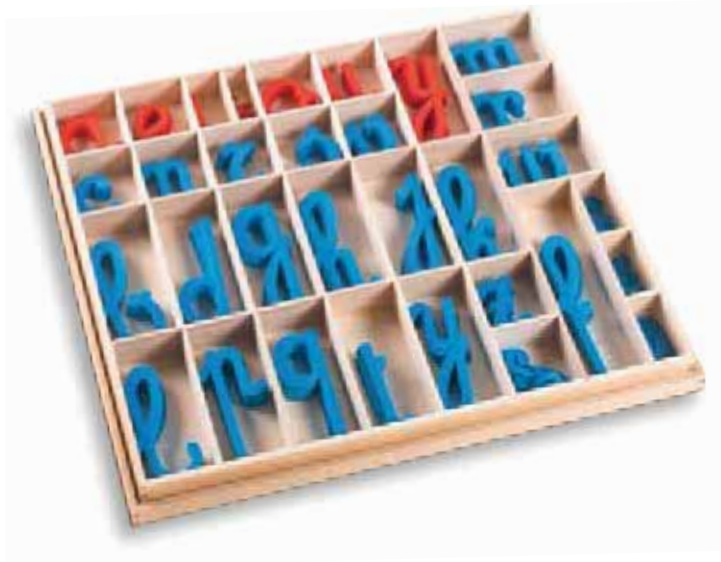
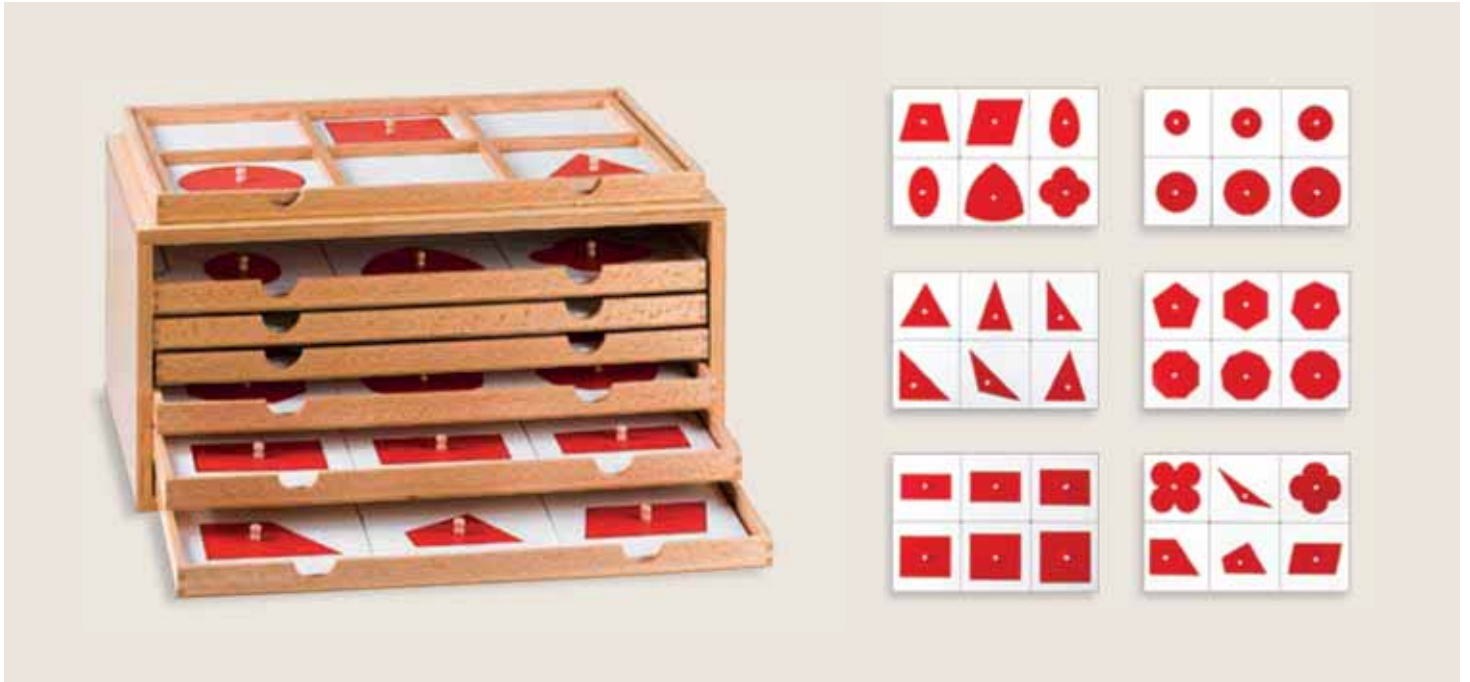

GAM ha radici nella storia della pedagogia. Nasce dall'antica falegnameria della città di Gonzaga che ha prodotto i primi materiali educativi e arredi disegnati da Maria Montessori. GAM è l'unica azienda italiana e una delle quattro al mondo ad avere l'approvazione ufficiale dell'AMI, Association Montessori Internationale.

GAM is deeply rooted in the history of pedagogy. It was born from the old carpentry shop of the city of Gonzaga which produced the first educational materials and furnishings designed by Maria Montessori. GAM is the only Italian company - and one of the four in the world - to have obtained the official approval from AMI, the Montessori International Association.

DESIGN GAM

GAM DESIGN



Every truly modern library - big or small - is so many things together: a cultural space, a community center, a place of identity, an open environment for meetings, events, initiatives.

Every library is a new project to GAM. A project carried out in relation to the context by listening to the users' needs, accurate design of the spaces, attention to detail.

Ogni biblioteca davvero moderna, grande o piccola, è tante cose insieme: spazio di cultura, centro di una comunità, luogo di identità, ambiente aperto per incontri, eventi, iniziative.

Per GAM ogni biblioteca è un nuovo progetto. Un progetto fatto rapporto con il contesto, di ascolto delle esigenze, disegno accurato degli spazi, cura dei particolari.



CERTIFICAZIONI CERTIFICATIONS



I prodotti GAM sono conformi alle norme tecniche del settore. Sono testati per sicurezza, resistenza e non tossicità. Vernici e coloranti sono atossici, contenuto di formaldeide in classe E1, imbottiti in classe di reazione al fuoco T1M, su richiesta arredi lignei in classe 1. I prodotti GAM sono conformi ai CAM (Criteri Ambientali Minimi).

All GAM products comply with the technical standards of the sector. They are tested for safety, resistance, and non-toxicity. Paints and colors are non-toxic, class E1 formaldehyde content, T1M fire rating upholstery; class 1 wooden furnishing on request. GAM products comply with CAM (minimum environmental criteria).





Product design, art direction, copywriting – **Giovanni Fumagalli**
cc91 design & research

Graphic design – **Simona Malizia**

Content management – **Anna Prandi, Andrea Maiocchi**

**ARREDI PER SCUOLE
E SERVIZI PER L'INFANZIA
ARREDI PER BIBLIOTECHE
MATERIALI MONTESSORI
EARLY-YEARS FURNITURE
SCHOOL FURNITURE
LIBRARY FURNITURE
MONTESSORI MATERIALS**

